



Operating Instructions

DTX4200XP 80 Channel UHF Citizen Band Radio

Keep this user guide for future reference. Always retain your proof of purchase in case of Warranty service.
www.oricom.com.au

When a narrowband radio receives a transmission from an older wideband radio the speech may sound loud and distorted – simply adjust your radio volume for the best listening performance. When an older wideband radio receives a signal from a new narrowband radio the speech may sound quieter - simply adjust your radio volume for best listening performance. When operating a narrowband radio or Channel 41 - 80 interference is possible from wideband radios transmitting on high power or on adjacent frequency.

The issues described above **are not a fault of the radio** but a consequence of mixed use of wideband and narrowband radios.



This unit complies with all relevant Australian and New Zealand approval requirements AS/NZS 4365:2011



Introduction	4
Important information	5
Installation of your Oricom Radio.....	6
Controls and Indicators	8
Operations	12
UHF CB channels and frequencies	27
Express Warranty (Australia)	31

Need Help?

If you need assistance setting up or using your Oricom product now or in the future, call Oricom Support.

Australia (02) 4574 8888
www.oricom.com.au
Mon-Fri 8am – 6pm AEST

New Zealand 0800 67 42 66
www.oricom.co.nz
Mon-Fri 10am – 8pm NZST

Introduction

Thank you for choosing the Oricom DTX4200XP 5 watt UHF CB Radio.

Oricom is a 100% Australian owned and operated company, engineering radio communication products specifically for the diverse and unique conditions of Australia and New Zealand since 2003. This product was manufactured in Korea under strict quality control.

Key Features

- Dual receive
- IP54 dust and splash resistant
- 3 memory groups of 16 channels per group
- 96 Multi-colour backlight display
- Backlight brightness (5 pre-set levels plus auto)
- Fast scanning 80 channels within 3 seconds
- Rotary volume/channel and squelch control
- Duplex
- 38 CTCSS & 104 DCS codes
- Heavy duty diecast metal chassis
- Slide-in mounting bracket
- Auto power off (off/1h/2h/4h)
- 3.5mm external jack (for optional external speaker (Model No. SPE85))

Optional Accessories (See page 7 for details)

External speaker (SPE85)

Magnetic microphone holder (MMM100)

Please read before installing or operating your Oricom Radio

The operation of your UHF radio in Australia and New Zealand is subject to conditions in the following licenses:

In Australia the ACMA Radio communications (Citizen Band Radio Stations) and in New Zealand by MED the General User Radio License for Citizen Band Radio.

Safety Information and Warnings



WARNING

Potentially Explosive Atmospheres

Turn your radio OFF when in any area with a potentially explosive atmosphere. Sparks in such areas could cause an explosion or fire resulting in injury or even death.

NOTE: Areas with potentially explosive atmospheres are often, but not always clearly marked. They include fuelling areas such as below deck on boats; fuel or chemical transfer or storage facilities; areas where the air contains chemicals or particles, such as grain, dust, or metal powders; and any other area where you would normally be advised to turn off your vehicle engine.

Blasting Caps and Areas

To avoid possible interference with blasting operations, turn your radio OFF near electrical blasting caps or in a “blasting area” or in areas posted: “Turn off two way radios.” Obey all signs and instructions.

Electromagnetic Interference/Compatibility

Nearly every electronic device is susceptible to electromagnetic interference (EMI). To avoid the possibility of electromagnetic interference and/or compatibility conflicts, turn off your radio in any location where posted notices instruct you to do so such as health care facilities.



CAUTION

When installing your radio in your vehicle, check that during installation you do not damage any wiring or vehicle components that may be hidden around the mounting position. Ensure the installation does not interfere with the operation of the vehicle and meets all regulatory and safety requirements for accessories fitted to your vehicle.

For optimum performance your radio needs to be installed correctly. If you are unsure about how to install your radio, we suggest you have your radio professionally installed by a UHF specialist or Auto electrician. When installing the radio, avoid mounting it close to heaters or air conditioners. Never press the PTT or CALL button before connecting the antenna to the radio.

Wiring Methods

There are two possible wiring configurations for connecting to the vehicles power supply.

A. Radio stays ON when the ignition is switched OFF

Connect the radio's negative (black) lead to the vehicle chassis, or directly to the battery's negative terminal.

Connect the radio's positive (red) lead via the 3 Amp fuse to the battery's positive terminal. Alternatively, the positive lead could be connected at the fuse box at a point that has DC Power continuously available (preferably the battery side of the ignition switch) via the 3 Amp fuse.

B. Radio turns OFF with the ignition switch

Connect the radio's negative (black) lead to the vehicle's chassis, or directly to the battery's negative terminal.

The radio's positive (red) lead should connect to an accessory point in the vehicle's fuse box via the 3 Amp fuse.

Antenna information

The antenna (not supplied) is of critical importance, to maximize your output power and receiver sensitivity.

A poorly installed, inferior quality antenna or one not designed for the correct frequency band will give poor performance. You should only purchase an antenna designed for the 477MHz frequency band.

Antenna installation

1. Connect the antenna to the rear antenna socket using a PL259 coaxial connector (not supplied).
2. To obtain maximum performance from the radio, select a high quality antenna and mount it in a good location. **Never press the PTT or CALL button before connecting the antenna to the radio.**
3. For best performance always mount your antenna as high as possible and away from all other antennas or poles.

Optional Accessories

The following Oricom accessories can be purchased directly from Oricom. Visit oricom.com.au.

Optional Magnetic Microphone Holder



Mounting bracket for easy installation. **Model number MMM100.**

Optional External Speaker



Depending on the installation, it may be necessary to use an external speaker (not supplied) to give improved volume and clarity. This can be plugged into the EXT –SPK socket on the rear of the unit. **Model No. SPE85.**

Controls and Indicators

Front View

Oricom offer a unique Jog Wheel, which makes using the Controller Speaker Microphone simple and intuitive.

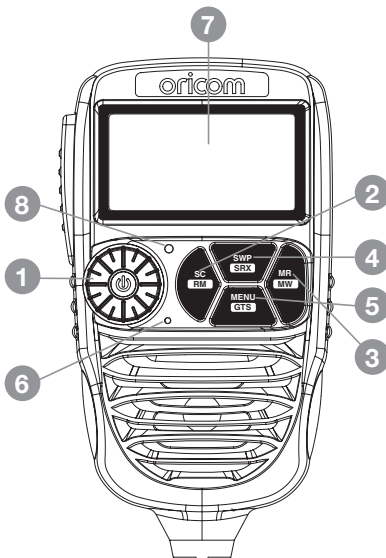

1. (Jog Wheel) Power on/off and Volume/channel/squelch and SVL (sub receiver volume)
2. Scan (open scan/memory group scan)/scan skip
3. Memory recall/memory write
4. Main & Sub channel swapping/SRX on/off
5. Menu/Group tone scan
6. Microphone
7. LCD display
8. Light sensor

Rear View

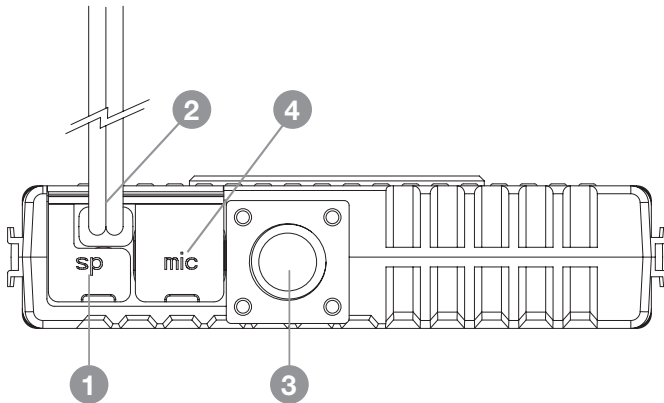

1. 3.5mm external jack for optional 8 ohm speaker
2. Power supply connection
3. Antenna connection
4. Microphone Jack

LCD Icons & Indicators

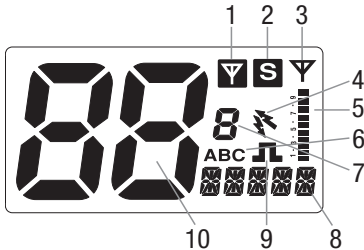

- | | |
|---|-----------------------------------|
| 1. Sub channel busy | 6. Group display (A, B, C groups) |
| 2. Sub channel on | 7. Group address channel |
| 3. Main receiver busy | 8. Status display |
| 4. Duplex on | 9. CTCSS or DCS on |
| 5. Signal strength & TX power & SWR meter | 10. Channel display |

Installation of the DTX4200XP and fitting optional accessories

Mounting the UHF radio

The universal mounting bracket supplied with your UHF radio allows overhead/dash mounting.

Mount the UHF radio via the bracket, securely with the supplied screws in the desired location, ensuring the surface is sturdy and can support the weight of the radio.

TO MOUNT: SLIDE INTO UNIVERSAL MOUNTING BRACKET

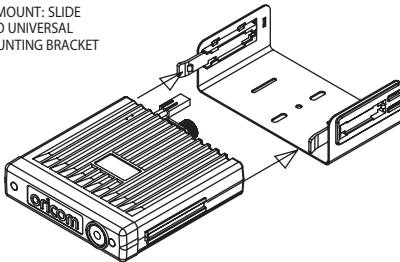

TO REMOVE: SLIDE OUT HOLDING BRACKETS AWAY FROM UHF RADIO

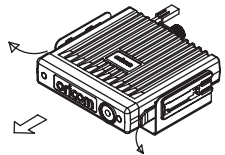

Installation Diagram

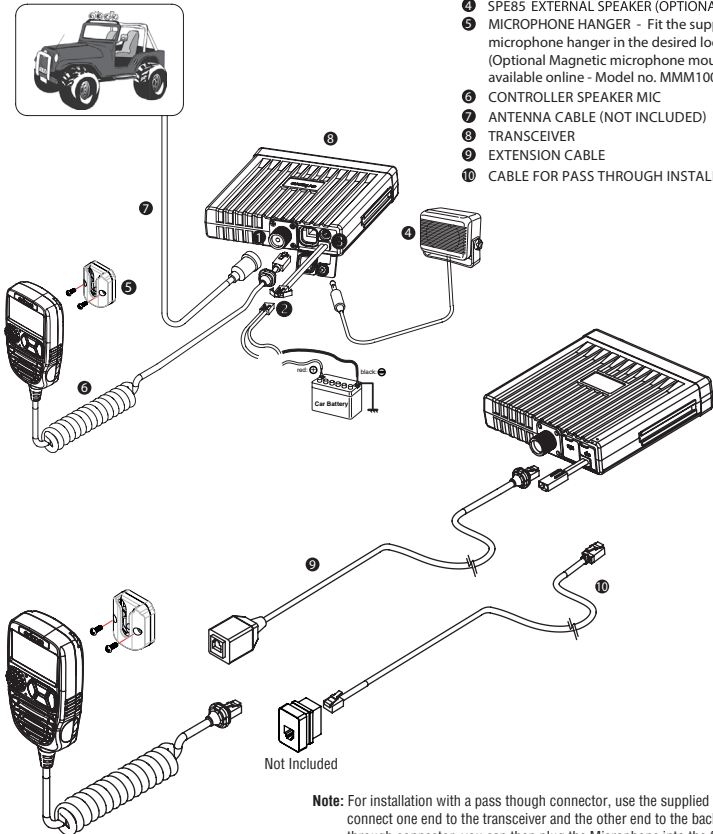

- 1 ANTENNA CONNECTOR
- 2 DC POWER CABLE-Connects to 12V.
Pay attention to polarities.
- 3 EXTERNAL SPEAKER JACK
- 4 SPE85 EXTERNAL SPEAKER (OPTIONAL ACCESSORY)
- 5 MICROPHONE HANGER - Fit the supplied microphone hanger in the desired location. (Optional Magnetic microphone mount is available online - Model no. MMM100)
- 6 CONTROLLER SPEAKER MIC
- 7 ANTENNA CABLE (NOT INCLUDED)
- 8 TRANSCEIVER
- 9 EXTENSION CABLE
- 10 CABLE FOR PASS THROUGH INSTALLATION

Not Included

Note: For installation with a pass through connector, use the supplied RJ45 cable to connect one end to the transceiver and the other end to the back of the pass through connector, you can then plug the Microphone into the front of the pass through connector.

Operations

Turning on the Power

Press and hold the Jog Wheel.

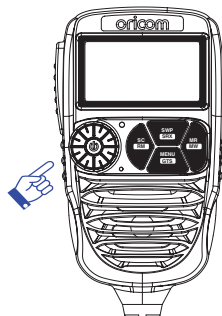

Setting the Volume

Rotate the Jog Wheel clockwise to adjust the sound level for comfortable reception.

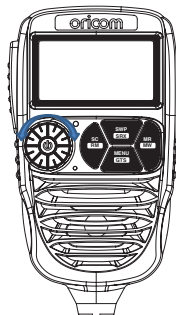

Selecting a channel

Press Jog Wheel once. "CH" will appear on the LCD.

Select the channel by rotating the Jog Wheel. Turn the Jog Wheel clockwise to adjust channel UP. Turn the Jog Wheel anti-clockwise to adjust channel DOWN.

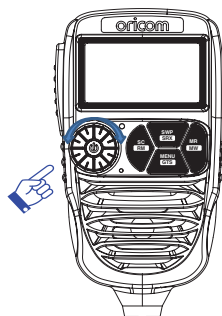

Setting the Squelch Level

1. Press Jog Wheel 2 times. The current squelch level is displayed.
2. Select the squelch level by rotating the Jog Wheel.

1 - Max sensitivity (Min. squelch)

15 - Min. sensitivity (Max/Tight squelch)

Off - Squelch open

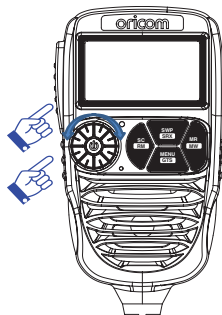

Setting SRX (Sub Receiver) Volume

1. Press Jog Wheel 3 times, then "SVL" is displayed.
2. Rotate the Jog Wheel to adjust the SRX volume.

Note :

- * If a button is not pressed within 2 seconds the radio will automatically exit the sub display of "VOL" "CH" "SQL" and "SVL".

PTT (Push-To-Talk) button

Pressing the PTT button activates the transmitter.

The RF (radio frequency) level will appear on the LCD display as you are transmitting.

To receive, release the PTT button and then TX will disappear on the LCD display.

When transmitting, hold the Mic two inches (5cm) from your mouth and speak clearly in a normal voice across the front of the Mic area.

Scanning

The Scan feature allows you to search for active channels automatically.

There are 3 scanning modes:

Open Scan, Group Memory Scan and Group tone Scan (a special case of Group Memory Scan).

Open scan

Press SC/RM to start scan. The OS-SC sub menu display will appear on the LCD display.

When a signal is found, scanning will stop at that channel to allow the signal to be heard, then resume scanning when the channel is clear again.

The scan resume time can be set to 5, 10 or 15 seconds of P5 (default).

ch ↻ 1-2-3-4-5-6-7 77-78-79-80 ↻

Note: During open scan rotating the Jog Wheel will not change the scan direction.

To stop the scan, press the SC/RM button or press the PTT.

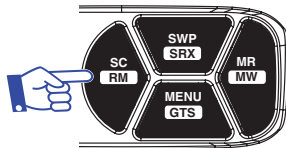

Remove Memory in Scanning

To remove a channel from the scan, press and hold SC/RM button for 2 seconds.

The channel will be removed from the current scan. When the scan stops, the removed channel will be reinstated.

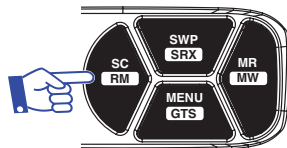

For example we are removing CH02 from the scan. You may want to remove this channel due to constant noise.

1. Press SC/RM button for 2 seconds.
2. Scanning will resume.
3. Channel 02 is removed from this scan.

Scan 1-2-3-4-5-6-7 77-78-79-80

RM Scan 1-3-4-5-6-7 77-78-79-80

Note: Up to 10 channels can be removed for the current scan.

Group Memory Scan

Memory scan must be stored to the memory channels in groups A to C. Refer to memory recall function on page 16.

1. Press MR/MW button to change between A, B, C (A,B,C will start flashing).

When A, B, C are flashing, all groups will be scanned starting with the selected group. When A, B and C are not flashing, then only the selected group will scan.

2. Press Scan button to start group scan.

The MS-SC sub menu display appears on the LCD.

3. To stop Group memory Scan, press SC/RM button or PTT.

Group Tone Scan

When Group Tone Scan is enabled, it will allow continual communication across congested channels.

Group tone scan channels stored into Group memory scan and only opens the squelch for signals with the correct subcode (38 CTCSS or 104 DCS tone).

To achieve this, all radios in your group must have the same channels in A, B, C memory (group memory channels) and use the same Subcode (38 CTCSS and 104 DCS tone).

By scanning only group channels, radios in the network will be able to detect and receive group transmissions which will be continual communication without interruption. When transmitting in this mode, the radio switches to an unused group channel if it detects another signal with no code/the wrong code, on the channel last used by the group.

1. Press and hold MENU/GTS button to activate Group Tone Scan.

All group tone scan stored into Group memory channel and CTCSS 01 (67Hz) is set for Group Tone Scan.

The group tone code can be changed in the settings menu.

2. To stop Group memory Scan, Press MENU/GTS button or PTT.

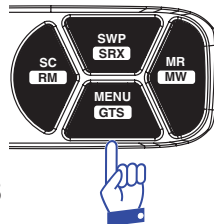

Memory Recall

This feature allows the user to recall the stored channels using the MR button.

To access the stored channels, simply press the "MR" button, and the "A" will appear at the right side on the LCD. Press the MR button again to cycle through A - B - C (A,B,C will start flashing).

When A, B and C are flashing, press SC/RM button to start all memory group scanning.

For scanning A, B or C only, select non flashing preferred group (A, B or C) press SC/RM.

The DTX4200XP has no information stored in the memory channels.

Memory Write

Select the channel you want to store.

For this example we will write CH09 to B group and group channel 8.

1. Press and hold the MR/MW button to store a channel.
"A" will appear and the group channel will flash.
2. Press MR/MW button to select B group.
3. Press Jog Wheel to engage CH mode.
4. Rotate Jog Wheel until 8 is shown in group channel display.
5. Press and hold MR/MW button to save & exit from memory write.

SWP (Swapping Dual RX channel)

The DTX4200XP can receive two channels simultaneously.

The main receiver default channel is 12 and Sub receiver default channel is 40.

The Sub channel can be turned on and off by pressing and holding the SWP/SRX button. The "S" indicator on the display will be on if the SRX is on.

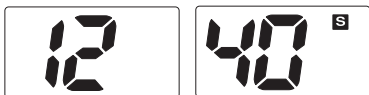

It is not possible to transmit on the SRX channel you must swap the SRX and Main RX to transmit on that channel.

To adjust the volume of the SRX channel, push the channel change selector 3 times, the display will show SVL and the level. Adjust desired volume level by rotating channel change selector, the setting will automatically save, press PTT to exit.



SRX On/Off

Press and hold SWP/SRX button to turn SWP/SRX off.









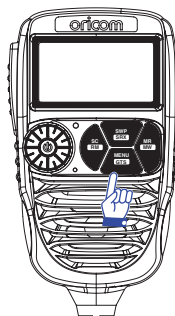

To return to Dual RX mode, press and hold the SRX button for 2 seconds.









Menu list

- * Press MENU/GTS button to access menu.
- * Use the Jog Wheel to change the value of each setting.
- * If a button is not pressed within 8 seconds the radio will automatically exit the menu mode.
- * You can exit the menu at any time by briefly pressing PTT button.
- * Please see below menu modes.



Function	Step	Display	Default
Duplex On/Off	Off		On
	On		
CTCSS and DCS	Off		Off
	to 104		
Group Tone Scan	CT1(67Hz)		CT1 (67Hz)
	to DCS104		
Backlight LED colour	0		87(Sky Blue)
	to 95		
Backlight Dimmer	Auto		4
	to 5		
Factory Reset	User		User reset
	Factory		
Squelch tail	Off		Off
	On		

Operations

Busy channel lock	Off		Off
	On		
Key Beep	Off		Off
	On		
Logo Display	On		On
	Off		
TPI	On		On
	Off		
Scan resume time	P5		P5
	to 5,10,15		
Auto power Off	Off		Off
	to 1H,2H,4H		
Software version	ver--3		

Duplex

General

Your radio has a Repeater Access function to allow use of local repeater stations (if available in your area). Repeaters are shared radio systems installed by interested parties (clubs, local business etc.) that receive transmissions on specific channels and re-transmit (or repeat) the received signal to another channel.

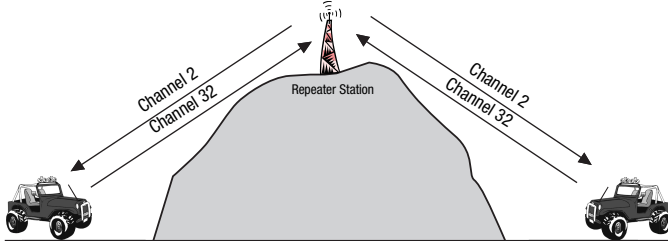

The Repeater Access function can be set (from channel 1 to 8 and 41 - 48) used by local repeater stations. When activated, your radio will receive the Repeater on its specific channel (all repeater outputs are on channel 1 to 8 and 41 to 48) but transmit to the repeater channel 31 through 38 and 71 to 78.

(Factory default is set to On for all repeater channels).

e.g.

CH01 on Duplex mode will receive on CH01 but transmit on CH31.

CH02 on Duplex mode will receive on CH02 but transmit on CH32.

If you transmit on CH01 duplex mode, you are actually transmitting on CH31.

The repeater station receives your signal on CH31 and retransmits on CH01.

Your UHF radio allows you to pre-select Duplex operation individually on each channel.

CH and Number	Simplex mode Transmit/Receiver	Duplex mode Transmit/Receiver
	Frequency (MHz)	Frequency (MHz)
1	476.425	477.175 CH31
2	476.450	477.200 CH32
3	476.475	477.225 CH33
4	476.500	477.250 CH34
5	476.525	477.275 CH35
6	476.550	477.300 CH36
7	476.575	477.325 CH37
8	476.600	477.350 CH38
41	476.4375	477.1875 CH71
42	476.4625	477.2125 CH72
43	476.4875	477.2375 CH73
44	476.5125	477.2625 CH74
45	467.5375	477.2875 CH75
46	476.5625	477.3125 CH76
47	476.5875	477.3375 CH77
48	476.6125	477.3625 CH78

For this example we are adopting CH01 as the channel being used for repeater use.

1. Press Menu to display Duplex setting.
2. Turn the Jog Wheel to change the setting between ON and OFF.
Note: You can only turn Duplex on when you are on a duplex channel.
3. Press PTT to save & exit from the menu mode.
4. Duplex on icon is displayed when a selected channel is set to Duplex mode. See LCD Icons & Indicators on page 10 No.3.

CTCSS and DCS setting

This feature allows you to receive signals only from callers who have selected the same CTCSS and DCS code.

DCS is similar to CTCSS. It provides 104 extra, digitally coded, squelch codes that follow after the 38 CTCSS codes. CTCSS 1 - 38, followed by DCS 1 - 104. (Displays A0 to A4 for 100 to 104)

CTCSS and DCS are not available on CH05 and CH35. For your reference a list of the available channels, corresponding frequencies and guidelines for their use and selection is in the CTCSS and DCS channel list on pages 29 and 30.

For Australia, channel 05 and 35 are reserved for Emergency calls.

Group Tone setting

The group tone scan default tone selected is CTCSS 01 (67Hz).

You can select from CTCC 01 - 38 to DCS 01 to 104 code for Group tone scan.

96 Multi-colour Backlight

You can select from 96 different multi-colour backlighting for the LCD backlight.

Backlight dimmer

You can reduce the brightness of the backlight by selecting levels 1 to 5, off or Auto, which will adjust the level of brightness depending on ambient light.

Factory Reset

To reset your radio, press and hold SC/RM button while turning the power on.

The display "AL-reset" or "User-reset" will indicate reset type.

The reset type can be selected in menu mode.

User reset will not delete any stored memory channels.

AL-reset will clear all memory channels and reset all settings back to factory.

Squelch Tail

Squelch Tail is the noise heard after the transmitting party releases the PTT and is heard by the receiving party.

If Squelch tail is turned on, on both radios this squelch noise will be muted.

Busy channel Lock

If the channel is already in use, you can prevent the UHF CB radio from accidentally transmitting over a channel already in use. This is particularly important when using CTCSS/DCS.

Key Beep

The key beep emits a tone when you press any of the buttons on the microphone (except PTT button).

Logo Display

The logo display function can be enabled or disabled.

TPI

TPI Transmit Power Indicator

VSWR Voltage Standing Wave Ratio is a measurement of how well the antenna (and cable) is matched to the radios output. It is best measured at the antenna as the cable can affect this measurement.

TPI indicates the level of RF power delivered to the antenna connector.

This allows you to see how well the antenna is matched to the UHF radio.

Generally a VSWR of less than 2 is an acceptable match.



Correct Antenna install with 5W



VSWR 1.2 with 4.5W



VSWR 2.6 with 4W



VSWR 3.5 with 3.5W

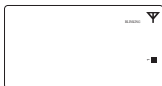

VSWR 4.4 with 3W



< 3W

The VSWR and Power test can vary depending on installation conditions. If TPI feature is turned off in the settings menu, the TPI indicator will show 5 bars during TX.

If an incorrect or no antenna is connected and power output is less than 3.5W, “ANT-X” will be displayed when TPI feature is turned on or off. When “ANT-X” is displayed, the radio has enabled protection mode and reduced RF output.

Scan resume time

You can select 5, 10, or 15 sec depending on your selection. SCAN will start again after a 5, 10, or 15 sec pause even though a signal is still present.

If P5 is selected, SCAN will stop on all channels as long as a signal is present. It will then resume SCAN again 5 seconds after no transmission is present.

Auto power OFF

The auto power off function is activated when no transmitting and no key function is present for the time selected.

The automatic power off time can be adjusted to OFF, 1, 2, or 4 hours in menu mode.

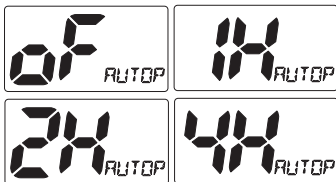

UHF CB channels and frequencies

Channel		Tx Freq	Rx Freq	Channel		Tx Freq	Rx Freq
		MHz	MHz			MHz	MHz
01*		476.4250	476.4250	21		476.9250	476.9250
	41*	-	476.4375		61‡	—	—
02*		476.4500	476.4500	22†		476.9500	476.9500
	42*	-	476.4625		62‡	—	—
03*		476.4750	476.4750	23†		476.9750	476.9750
	43*	-	476.4875		63‡	—	—
04*		476.5000	476.5000	24		477.0000	477.0000
	44*	-	476.5125		64	477.0125	477.0125
05*		476.5250	476.5250	25		477.0250	477.0250
	45*	-	476.5375		65	477.0375	477.0375
06*		476.5500	476.5500	26		477.0500	477.0500
	46*	-	476.5625		66	477.0625	477.0625
07*		476.5750	476.5750	27		477.0750	477.0750
	47*	-	476.5875		67	477.0875	477.0875
08*		476.6000	476.6000	28		477.1000	477.1000
	48*	-	476.6125		68	477.1125	477.1125
9		476.6250	476.6250	29		477.1250	477.1250
	49	476.6375	476.6375		69	477.1375	477.1375
10		476.6500	476.6500	30		477.1500	477.1500
	50	476.6625	476.6625		70	477.1625	477.1625
11		476.6750	476.6750	31*		477.1750	477.1750
	51	476.6875	476.6875		71*	477.1875	-
12		476.7000	476.7000	32*		477.2000	477.2000
	52	476.7125	476.7125		72*	477.2125	-
13		476.7250	476.7250	33*		477.2250	477.2250
	53	476.7375	476.7375		73*	477.2375	-
14		476.7500	476.7500	34*		477.2500	477.2500
	54	476.7625	476.7625		74*	477.2625	-
15		476.7750	476.7750	35*		477.2750	477.2750
	55	476.7875	476.7875		75*	477.2875	-
16		476.8000	476.8000	36*		477.3000	477.3000
	56	476.8125	476.8125		76*	477.3125	-
17		476.8250	476.8250	37*		477.3250	477.3250
	57	476.8375	476.8375		77*	477.3375	-
18		476.8500	476.8500	38*		477.3500	477.3500
	58	476.8625	476.8625		78*	477.3625	-
19		476.8750	476.8750	39		477.3750	477.3750
	59	476.8875	476.8875		79	477.3875	477.3875
20		476.9000	476.9000	40		477.4000	477.4000
	60	476.9125	476.9125		80	477.4125	477.4125

* The primary use for these channels is repeater operation using 750 kHz offset. Channels 1-8 inclusive are used for mobile reception and channels 31-38 for mobile transmission. Note that additional channels 41-48 and 71-78 are also available for repeater operation to supplement channels 1-8 and 31-38 respectively as approved by the ACMA CBRS Class Licence in Australia and the MED GURL in New Zealand. In addition, any designated repeater channel may be used for simplex operation in areas where it is not used for repeater operation.

† Speech telephony shall be inhibited on these channels.

‡ At the time of production Channels 61, 62 and 63 are guard channels and are not available for use.

Channels 5 and 35 (paired for Duplex repeaters) are reserved as emergency channels and should be used only in an emergency.

CTCSS and DCS will not operate on these channels.

A list of currently authorised channels can be obtained from the ACMA website in Australia and the MED website in New Zealand. Channel 11 is a calling channel generally used to call others and channel 40 is the customary road vehicle channel.

Once contact is established on the calling channel, both stations should move to another unused "SIMPLEX" channel to allow others to use the calling channel.

UHF CB Radios normally transmit and receive on the same frequency which is known as the simplex operation.

Channels 22 and 23 are for Telemetry and Telecommand use, voice communications are not allowed on these channels by law.

Channel 9 and above are the best choices for general use in Simplex mode.

38 CTCSS CODE LIST

CODE	Frequency(Hz)	CODE	Frequency(Hz)
OFF	OFF	20	131.8
1	67.0	21	136.5
2	71.9	22	141.3
3	74.4	23	146.2
4	77.0	24	151.4
5	79.7	25	156.7
6	82.5	26	162.2
7	85.4	27	167.9
8	88.5	28	173.8
9	91.5	29	179.9
10	94.8	30	186.2
11	97.4	31	192.8
12	100.0	32	203.5
13	103.5	33	210.7
14	107.2	34	218.1
15	110.9	35	225.7
16	114.8	36	233.6
17	118.8	37	241.8
18	123.0	38	250.3
19	127.3		

DCS codes table

Code NO.	DCS Code (Octal)	Code NO.	DCS Code (Octal)	Code NO.	DCS Code (Octal)
1	023	36	223	71	445
2	025	37	225	72	446
3	026	38	226	73	452
4	031	39	243	74	454
5	032	40	244	75	455
6	036	41	245	76	462
7	043	42	246	77	464
8	047	43	251	78	465
9	051	44	252	79	466
10	053	45	255	80	503
11	054	46	261	81	506
12	065	47	263	82	516
13	071	48	265	83	523
14	072	49	266	84	526
15	073	50	271	85	532
16	074	51	274	86	546
17	114	52	306	87	565
18	115	53	311	88	606
19	116	54	315	89	612
20	122	55	325	90	624
21	125	56	331	91	627
22	131	57	332	92	631
23	132	58	343	93	632
24	134	59	346	94	654
25	143	60	351	95	662
26	145	61	356	96	664
27	152	62	364	97	703
28	155	63	365	98	712
29	156	64	371	99	723
30	162	65	411	100(do0)	731
31	165	66	412	101(do1)	732
32	172	67	413	102(do2)	734
33	174	68	423	103(do3)	743
34	205	69	431	104(do4)	754
35	212	70	432		

Express Warranty (Australia)

This Express Warranty is provided by Oricom International Pty Ltd ABN 46 086 116 369, Unit 1, 4 Sovereign Place, South Windsor NSW 2756, herein after referred to as “Oricom”.

Oricom warrants that the product is free from defects in materials or workmanship during the Express Warranty Period. This Express Warranty does not extend to any product from which the serial number has been removed or was purchased outside of Australia.

The benefits of this Express Warranty are in addition to other rights and remedies you may have under the Australian Consumer Law. Our goods come with guarantees that cannot be excluded under the Australian Consumer Law. You are entitled to a replacement or refund for a major failure and compensation for any other reasonably foreseeable loss or damage. You are also entitled to have the goods repaired or replaced if the goods fail to be of acceptable quality and the failure does not amount to a major failure. In the event of a minor failure, Oricom reserves the right to choose to repair or replace the product.

The Express Warranty Period will be a period of 5 years beginning on the date of purchase of the product evidenced by your dated sales receipt. You are required to provide proof of purchase as a condition of receiving Express Warranty services.

You are entitled to a replacement product or repair of the product at our discretion according to the terms and conditions of this document if your product is found to be faulty within the Express Warranty Period. This Express Warranty extends to the original purchaser only and is not transferable.

Products distributed by Oricom are manufactured using new materials or new and used materials equivalent to new in performance and reliability. Spare parts may be new or equivalent to new. Spare parts are warranted to be free from defects in material or workmanship for thirty (30) days or for the remainder of the Express Warranty Period of the Oricom branded product in which they are installed, whichever is longer. During the Express

Express Warranty (Australia)

Warranty Period, Oricom will where possible repair and if not replace the faulty product or part thereof. All component parts removed under this Express Warranty become the property of Oricom. In the unlikely event that your Oricom product has a recurring failure, Oricom may always, subject to the Competition and Consumer Act 2010, at its discretion, elect to provide you with a replacement product of its choosing that is at least equivalent to your product in performance.

No change to the conditions of this Express Warranty is valid unless it is made in writing and signed by an authorised representative of Oricom.

Oricom will not be liable under this Express Warranty, and to the extent permitted by law will not be liable for any defect, loss, damage or injury arising out of or in connection with a:

1. Failure by you to adhere to the warnings and follow the instructions set out in this user guide for the proper installation and use of the product;
2. Willful misconduct or deliberate misuse by you of the product;
3. Any external cause beyond our control, including but not limited to power failure, lightning or over voltage; or
4. Modification to the product or services carried out on the product by anyone other than Oricom or Oricom's authorised service provider.

How to make a claim under your Express Warranty in Australia

Oricom has a simple warranty process for you to follow:

- Please call or email our Customer Support Team, 02 4574 8888 or support@oricom.com.au.
- A Customer Support Team member will verify after troubleshooting with you if your product qualifies under warranty. If so, they will give you a Product Return Authorisation number.
- We will then email a Return Authorisation form and a Repair Notice (if necessary), together with instructions on how to return the product for warranty service.

Please note that if a Customer Support Team member advises that your product does not qualify for return, this warranty does not apply to your product. Products that are authorised to be returned to Oricom in Australia must include all of the following:

- A completed Return Authorisation form
- A copy of your Proof of Purchase (please keep your original copy)
- The faulty product, including all accessories.

Send the approved returns to:

Oricom International Pty Ltd
Locked Bag 658
South Windsor NSW 2756 Australia

Please note that this Express Warranty excludes expenses incurred by you in returning any faulty product to us. You must arrange and pay any expenses incurred (including postage, delivery, freight, transportation or insurance of the product) to return the faulty product to us, however, we will arrange delivery of the repaired or replaced faulty product to you.

Important Information

Repair Notice

Please be aware that the repair of your products may result in the loss of any user-generated data (such as stored telephone numbers, text messages and contact information). Please ensure that you have made a copy of any data saved on your product before sending for repair. Please also be aware that products presented for repair may be replaced by refurbished products or parts of the same type rather than being repaired.

ORICOM CUSTOMER SUPPORT

Oricom have a trained and dedicated team of Customer Support Representatives, each with the knowledge and resources to assist in answering your questions quickly and efficiently.

Oricom Support - Australia

For all product enquiries, troubleshooting or to discuss the range of Oricom products, feel free to contact Oricom or visit our website for answers to frequently asked questions.

(02) 4574 8888

Monday - Friday 8am – 6pm AEST

Email: support@oricom.com.au

www.oricom.com.au

Oricom Support - New Zealand

0800 674 266

Monday - Friday 11am - 7pm NZST

Email: support@oricom.co.nz

