

ORICOM CUSTOMER SUPPORT

Oricom have a trained and dedicated team of Customer Support Representatives, each with the knowledge and resources to assist in answering your questions quickly and efficiently.

Oricom Support - Australia

For all product enquiries, troubleshooting or to discuss the range of Oricom products, feel free to contact Oricom or visit our website for answers to frequently asked questions.

02 4574 8888

Monday - Friday 8am – 6pm AEST

Email: support@oricom.com.au

www.oricom.com.au

Oricom Support - New Zealand

0800 674 266

Monday - Friday 10am – 8pm NZST

Email: support@oricom.co.nz



Ref: 19102022



Operating Instructions

UHF2200 80 Channel UHF 2 Way
Citizen Band Radio

Keep this user guide for future reference.
Always retain your proof of purchase in case of warranty service.

www.oricom.com.au



Need Help?

If you need assistance setting up or using your Oricom product now or in the future, call Oricom Support.

Australia 02 4574 8888
www.oricom.com.au
Mon-Fri 8am – 6pm AEST

New Zealand 0800 67 42 66
www.oricom.co.nz
Mon-Fri 10am – 8pm NZST

Safety Information and Warnings	4
Getting Started	10
Oricom UHF2200 instructions	15
Operation.....	17
Channel Frequency Table	26
Troubleshooting guide.....	29
Customer Support.....	30
Express Warranty (Australia)	31

When a narrowband radio receives a transmission from an older wideband radio the speech may sound loud and distorted – simply adjust your radio volume for the best listening performance. When an older wideband radio receives a signal from a new narrowband radio the speech may sound quieter - simply adjust your radio volume for best listening performance. When operating a narrowband radio on Channel 41 - 80 interference is possible from wideband radios transmitting on high power or on adjacent frequency.

The issues described above **are not a fault of the radio** but a consequence of mixed use of wideband and narrowband radios.



This unit complies with all relevant Australian and New Zealand approval requirements AS/NZS 4365:2011 including Radiocommunications Equipment (General) Rules 2021, EN62209-1, EN62209-2.

Safety Information and Warnings



WARNING

Information on Safe Operation

Read This Information Before Using Your Oricom Radio. The operation of your UHF radio in Australia and New Zealand is subject to conditions in the following licenses:

In Australia, the ACMA Radio communications (Citizen Band Radio Stations) and in New Zealand by MED the General User Radio License for Citizen Band Radio.

Radio Antenna

Do not use any radio that has a damaged antenna. If a damaged antenna comes in contact with the skin, a minor burn may result.

Unauthorized antennas, modifications, or attachments could damage the radio and violate compliance. Do NOT change or modify the antenna. Do NOT hold the antenna when the radio is "IN USE." Holding the antenna reduces range and may cause bodily harm.

Safety and general use whilst in a vehicle

Check the State and Federal laws and regulations regarding the use of two way radios in the area where you drive, and always obey them.

For Vehicles fitted with Air Bags

Do not place your radio in the area over an air bag or in the air bag deployment area. Air bags inflate with great force. If a radio is placed in the air bag deployment area and the air bag inflates, the radio may be propelled with great force and cause serious injury to the occupants of the vehicle.



WARNING

Read all these Safety Warnings before you install batteries.

- Do not dispose of the batteries in a fire as they may explode.
- Exercise extreme care when handling batteries in order not to short the battery with conducting materials such as rings, bracelets and keys. The battery or conduction material may overheat explode and or cause burns.
- Never replace batteries in a potentially explosive atmosphere (such as where gas is leaking) as contact sparking may occur while installing or removing the batteries and cause a fire or an explosion.
- Do not modify, cut, disassemble, crush, bend, puncture, heat or damage the batteries.
- If batteries leak, do not let the battery liquid touch skin or eyes. If this happens, immediately flush the affected areas with water, and seek medical assistance. Released electrolyte is corrosive and may cause damage to the eyes and skin. It may be toxic if swallowed.
- Do not immerse or expose the batteries to water or other liquids.
- Never use damaged batteries as they may explode.
- Remove batteries when they are no longer able to hold a charge and when the equipment will not be used for an extended period of time.
- Dispose of batteries according to local regulations, never in your household rubbish.



WARNING:

Risk of explosion if battery is replaced by an incorrect type.

Potentially Explosive Atmospheres

Turn your radio OFF when in any area with a potentially explosive atmosphere. Sparks in such areas could cause an explosion or fire resulting in injury or even death.

NOTE: Areas with potentially explosive atmospheres are often, but not always clearly marked. They include fueling areas such as below deck on boats; fuel or chemical transfer or storage facilities; areas where the air contains chemicals or particles, such as grain, dust, or metal powders; and any other area where you would normally be advised to turn off your vehicle engine.

Blasting Caps and Areas

To avoid possible interference with blasting operations, turn your radio OFF near electrical blasting caps or in a “blasting area” or in areas posted: “Turn off the two way radio.” Obey all signs and instructions.



Exposure to Radio Frequency Energy

Your Oricom two-way radio complies with Australian Communications Authority Radio communications (Electromagnetic Radiation-Human Exposure) Standard, 2003.

To assure optimal radio performance and make sure human exposure to radio frequency electromagnetic energy is within the guidelines set out in the above standards always adhere to the following procedures.

Transmit and Receive Procedure

Your two-way radio contains a transmitter and a receiver. To control your exposure and ensure compliance with the general population/uncontrolled environment exposure limits, always adhere to the following procedure:

- Transmit no more than 50% of the time.
- To receive calls, release the PTT button.
- To transmit (talk), press the Push to Talk (PTT) button.

Transmitting 50% of the time, or less, is important because the radio generates measurable RF energy exposure only when transmitting (in terms of measuring standards compliance).

Always hold the radio approximately 5cm in front of your mouth with the antenna pointing away from your head.



Radio Operation and EME Exposure

Unauthorized antennas, modifications, or attachments could damage the radio and violate compliance.

Do NOT hold the antenna when the radio is "IN USE." Holding the antenna reduces the effective range.

Do not use the radio if the antenna is damaged. If a damaged antenna makes contact with your skin, a minor burn can result.

If you wear a radio on your body when transmitting, always fit the radio on the belt clip (supplied). Always ensure the radio and its antenna are at least 5cm from your body when transmitting.

Electromagnetic Interference/Compatibility

Nearly every electronic device is susceptible to electromagnetic interference (EMI). To avoid the possibility of electromagnetic interference and/or compatibility conflicts, turn off your radio in any location where posted notices instruct you to do so such as health care facilities.

Aircraft

When instructed to do so, turn off your radio when onboard an aircraft. Any use of a radio must be in accordance with applicable regulations per airline crew instructions.



WARNING

Medical Devices - Pacemakers

The Advanced Medical Technology Association recommends that a minimum separation of 6 inches (15cm) be maintained between a handheld wireless radio and a pacemaker. These recommendations are consistent with the independent research by and recommendations of the U.S. Food and Drug Administration.

People with pacemakers should:

- ALWAYS keep the radio more than 15cm from their pacemaker when the radio is turned ON.
- Not carry the radio in the breast pocket.
- Use the ear opposite the pacemaker to minimize the potential for interference.
- Turn the radio OFF immediately if there is any reason to suspect that interference is taking place.

Medical Devices - Hearing Aids

Some radios may interfere with some hearing aids. In the event of such interference, you may want to consult your hearing aid manufacturer to discuss alternatives.



WARNING

Other Medical Devices

If you use any other personal medical device, consult the manufacturer of your device to determine if it is adequately shielded from RF energy. Your physician may be able to assist you in obtaining this information.

General warnings

Never use your radio outdoors during a thunderstorm.

Keep the radio out of reach of babies and young children.

Installation

Removing the Belt Clip

Pull the belt clip latch away from the radio.

While pulling the belt clip latch, push up the belt clip.

Installing the Belt Clip

Slide the belt clip into the slot.

A “click” indicates the belt clip is locked into position.

Installing the Batteries

Lift the battery cover lock to open then remove the battery cover. Install the rechargeable batteries by following the orientation as shown in Figure 1. Replace the Battery compartment cover and lock.

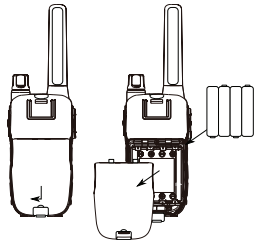

Figure 1

WARNING

- Follow the polar directions and insert 4 x AAA 600mA Ni-MH rechargeable batteries.
- Incorrect positioning can damage both the batteries and unit.
- Don't try to recharge non-rechargeable batteries.
- Make sure the battery compartment cover is securely locked in place when you are charging the batteries.
- Dispose of used batteries safely according to local regulations, never in your household rubbish.
- Don't leave dead batteries in the unit. They might leak.

CHARGING BATTERIES

When the “Battery level ” icon is low, you need to charge the battery with the enclosed USB charging cable.

CHARGING WITH USB CABLE

To charge, with the USB cable provided, plug the USB cable into a USB adaptor (not included) in a wall socket.

The cable LED will turn ON in green to indicate the power is connected.

Plug the other end into the radio earphone jack.

The cable LED will then turn red to indicate the radio is charging.

The LCD  icon will flash.

Note: If you don't turn off the radio, the radio will automatically turn off during charging. Once charging is complete, turn radio off, wait a few seconds then turn it back on.

Charge time from flat to full requires about 8 ~ 10 hours.

After charging, unplug the USB cable from the USB adaptor.

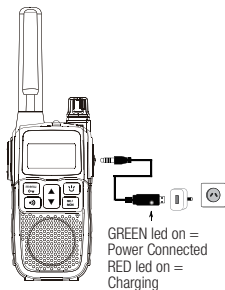

Transmitting Range

The talk range depends on the environment and terrain. In general the radio can reach further in wide open spaces, without obstructions such as hills or buildings. Range is affected by concrete structures, heavy foliage and by operating radios indoors or in vehicles. Don't try to use two radio units which are less than 1.5m (5 feet) apart. Otherwise, you may experience interference.



Optimal Range
Outdoors
Flat, open areas



Medium Range
Outdoors
Buildings or trees
Also near residential buildings



Minimal Range
Outdoors
Dense foliage or mountains.
Also inside some buildings

UHF2200 Pack Contents:

- 1 x UHF2200 UHF CB Radio
- 1 x USB Charging Cable
- 4 x AAA 600mA Ni-MH Rechargeable Batteries
- 1 x Belt Clip

Oricom UHF2200 Accessories

The following Oricom UHF2200 accessories can be purchased directly from Oricom. Visit www.oricom.com.au or call (02) 4574 8888.

Model No.	Description
2U0175	Heavy duty speaker microphone
2U0176	Twin charging cradle
2U0178	Car charger
2U0179	Ear bud mics
2U0180	Single belt clip
2U0181	AAA 600mA Ni-MH Rechargeable Battery

**FOR A FULL LIST OF CURRENT PARTS AND ACCESSORIES
VISIT www.oricom.com.au**

Oricom UHF2200 2-Way CB Radio

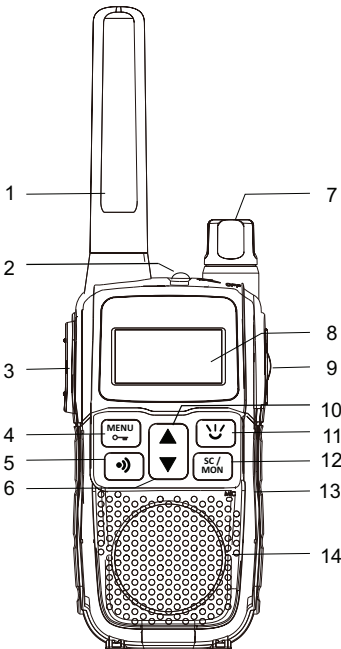

1. Antenna
2. Torch LED
3. PTT key
4. Menu / Key lock key
5. Call Tone key
6. Down key
7. Power On/Off/Volume Knob
8. LCD display
9. Earphone & Charger Jack
10. Up key
11. Torch On/Off key
12. Scan / Monitor key
13. Microphone
14. Speaker

LCD DISPLAY ICONS

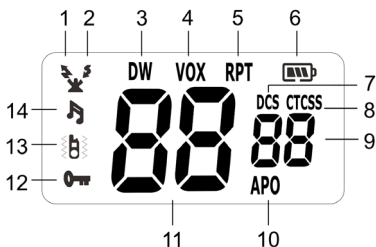

- | | |
|------------------|--------------------------|
| 1. TX | 8. CTCSS |
| 2. RX | 9. Code for CTCSS/DCS |
| 3. Dual Watch | 10. APO (Auto Power Off) |
| 4. VOX | 11. Main Channel Digits |
| 5. Repeater | 12. Key Lock |
| 6. Battery Level | 13. Vibrator |
| 7. DCS | 14. Call Tone |

Operation

Turning the Radio ON/OFF

To Turn ON;

Rotate the POWER/VOL knob clockwise until the LCD Screen turns ON and displays the current channel.

To switch OFF;

Rotate the POWER/VOL knob counter clockwise until the LCD screen turns blank and you hear a click.

Adjusting the Speaker Volume

After turning on the radio, you can adjust the volume level by rotating the Power/Vol knob.

Changing Channels

To select the main channel

Press ▲ or ▼ key to select your desired main channel number. Press the PTT key to confirm and quit or press MENU to continue to the next menu setting. LCD will display the channel frequency.





You have 10 seconds to decide before auto-reverting back to the main screen.

Your UHF2200 is simplex “one way at a time”. While you are speaking, you can not receive a transmission.

Your UHF2200 is an open--license band. Always identify yourself when transmitting on the same channel.

IMPORTANT: Before transmitting on a channel listen to ensure it is not already in use.

Key Lock

Press and hold  key for 3 seconds, LCD displays  icon. All keys are locked except PTT, torch and  key. To unlock, press and hold  key for 3 seconds again.

Torch

Press  key to turn on the LED torch. Press the  key again to turn the torch off.

Scanning Channels

Press the SC/MON key once, LCD will display SC/MON and radio will start scanning.

LCD display shows the scanning channel one by one.

It will stop at channels with a signal for a while.

Note: Please be aware that the scanning will stop at the channels with the same CTCSS / DCS as your radio setting only.

Press  or  key to continue scanning.

Or if you want to use this channel, press PTT to confirm and your radio will stay on this channel.

If there is no signal, it will continue to scan. Press SCAN key or PTT to exit Scan function and return to preset Channel.

Monitor (Zero squelch)

Press and hold SC/MON key to temporarily open the squelch in order to listen to signals that are too weak to keep the squelch permanently opened. Release the SC/MON key to stop.

Transmitting and Receiving

The radio has 75 main frequencies and 38 CTCSS codes or 83 DCS codes. You can communicate with any other user who is using the same combinations, providing they are within range. To transmit, press & hold the PTT key, LCD displays  TX icon indicating the radio is transmitting.

Hold the radio in a vertical position with the microphone 3-5 cm from your mouth and then speak.



When you finish speaking, release the PTT key.

The radio will automatically sound the received signal from the other radio on the same channel, the LCD will display the receive icon .

The transmission is SIMPLEX “one way at-a-time.” While you are speaking, you can not receive a transmission.

Adjust volume control if necessary.



RPT ON/OFF information

If a Repeater channel is selected, press MENU key once, then use  or  button to turn on or off.

PLEASE NOTE: if the selected channel is not a repeater channel, this feature is not available and all other menu features will require 1 button push less to select that feature.

CTCSS

Press Menu key MENU twice, the current CTCSS sub-channel number flashes on the LCD Screen.

Press the  or  button to select one of the 38 CTCSS sub-channels.

Operation

Press the PTT key to confirm and quit or press MENU to continue to the next menu setting.

Each channel also has 83 digital codes to let you set up a group of users for more private communication.

Press Menu key MENU 3 times, the DCS code is blinking on the LCD Screen.

Press the ▲ or ▼ button to select the desired DCS code.

Press the PTT key to confirm and quit or press MENU to continue to the next menu setting.

Note:

- The unit will use the last codes either CTCSS or DCS being selected and confirmed.

CTCSS = Coded tone controlled squelching system. This allows you to talk on a private sub channel on an active channel.

DCS is a digital extension of CTCSS. It provides extra, digitally coded, squelch codes that follow after the 38 CTCSS codes.

CTCSS 1 to 38, followed by DCS 1-83.

Dual Watch

The unit has dual watch function. You can monitor two channels, the current and another (dual watch) channel. If the unit detects a signal on either channel, it will stop and receive the signal.

Press the MENU key 4 times, LCD displays **DW** icon and the **CH** icon will flash.

Press ▲ or ▼ key to select the dual watch channel (1-80, except the current channel), or OF to turn OFF.

After function has been turned on, LCD will display **DW** icon.

Press the PTT key to confirm and quit or press MENU to continue to the next menu setting.

VOX

Voice operated transmitter, allows you to transmit with your voice without pressing the PTT button.

Your UHF2200 is equipped with an adjustable Voice Operated Transmitter (VOX) that can be used for automatic voice transmission.

You can enjoy talking and listening without pressing PTT key. The level of VOX sensitivity is shown by a number on the LCD Screen. At the highest level, the units will pick up softer noise (including background noise); and the lowest level, will pick up louder noise.

Press the MENU key 5 times, the LCD will display **VOX** icon and the VOX sensitivity digit will flash.

Press ▲ or ▼ key to select sensitivity level from “0F, 1, 2, 3” for “OFF, Low, Medium and High respectively.

After turning on the VOX function, LCD will display **VOX** icon.



Press the PTT key to confirm and quit or press MENU to continue to the next menu setting.

Please speak close to the mic in order to activate VOX function.

Note: VOX operation is not recommended if the radio will be used in a noisy or windy environment.

Call Tone

You can use 1 of 10 different “Call Tones” to get the attention of another user on the same channel.

Press the  key to send the selected tone, the tone will sound, the LCD will display the transmit  and the call tone  icons.

To select a call tone

Press the MENU key 6 times, the LCD will display the  icon and call the tone number will flash.

Press ▲ or ▼ key to select your desired call tone.

Press the PTT key to confirm and quit or press MENU to continue next menu setting.

VIBRATE MODE

The unit will vibrate to alert you when it receives a Call or radio voice signal from other UHF CB radios.

Press MENU key 7 times, the LCD will display “”.

Press ▲ or ▼ key to turn the vibrator on or off.

After turning on the function, LCD will display  icon.

Press PTT to confirm and quit or press MENU to continue next menu setting.

Note: Call tone and Vibrate can be activated at the same time. While the unit is in standby mode for over 30 seconds, it will vibrate once, upon receiving a Call or voice signal.

Key Tone

This feature allows the radio to emit a confirmation tone after pressing each button.

Press MENU key 8 times, LCD display “t o”.

Press ▲ or ▼ key to select the Key Tone On/Off.

Press PTT to confirm and quit or press MENU to continue next menu setting.

Roger Beep

The Roger Beep is a tone which is automatically transmitted whenever the PTT button is released.

Press MENU key 9 times, LCD display "r o".

Press ▲ or ▼ key to select the Roger beep On/Off.

Press PTT to confirm and quit or press MENU to continue next menu setting.

Auto Power Off

Press MENU key 10 times, LCD display **APO** icon.

Press ▲ or ▼ key to select auto power off time from 30, 60 and 90 mins.

Press PTT key to confirm and quit or press MENU to return to Main screen.

After turning on this feature, LCD will display **APO** icon and automatically turn off at the designated time.

Reset the unit

To reset the radio to default:

Power off the radio, press and hold "SCAN" + "PTT", and then Power ON.

Duplex operation via Repeaters

This feature allows you to use local repeater stations that are designed to automatically re-transmit your broadcast over a large area thus giving you increased range.

Repeater stations are privately operated radio systems installed throughout Australia.

For example, if you wish to access a repeater station in your area which operates on channel 2, you need to set the Duplex access on this Channel.

When you have turned on the Duplex setting in the menu for the selected channel (and you are within range of a local repeater), your radio will automatically transmit to the repeater on channel 32.

Turning on/off Duplex on channels

- a. Select the required channel to suit the repeater station you wish to access (Channels 1~8 and 41 ~ 48)
- b. Press the MENU key once, "RPT" icon will display.
- c. Press the Up or Down key to set the Repeater function to ON or OFF.
- d. Press the PTT key to confirm your setting.
- e. The RPT icon will display to indicate that Repeater function is set on that channel.

Receive Channel	1	2	3	4	5*	6	7	8
Transmit channel	31	32	33	34	35*	36	37	38

Receive Channel	41	42	43	44	45	46	47	48
Transmit channel	71	72	73	74	75	76	77	78

* Channel 5 is emergency channel only

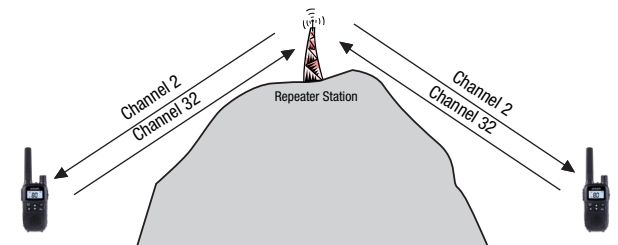

Channel Frequency Table

Radiocommunications (Citizen Band Radio Stations) Class Licence 2002

No licence is required to own or operate this radio in Australia and New Zealand. The Radiocommunications (Citizen Band Radio Stations) Class Licence 2002 contains the technical parameters, operating requirements, conditions of licence and relevant standards for Citizen Band (CB) radios. CB radios must comply with the class licence for their use to be authorised under the class licence.

UHF channels and frequencies

IMPORTANT NOTE: The operation of your UHF radio in Australia and New Zealand is subject to conditions in the following licenses:

In Australia the ACMA Radio communications (Citizen Band Radio Stations) and in New Zealand by MED the General User Radio License for Citizen Band Radio.

Channel Frequency Table

Channel		Tx		Channel		Rx	
		Freq				Freq	
		MHZ				MHZ	
01*		476.4250	476.4250	21		476.9250	476.9250
	41*	-	476.4375		61‡	—	—
02*		476.4500	476.4500	22†		476.9500	476.9500
	42*	-	476.4625		62‡	—	—
03*		476.4750	476.4750	23†		476.9750	476.9750
	43*	-	476.4875		63‡	—	—
04*		476.5000	476.5000	24		477.0000	477.0000
	44*	-	476.5125		64	477.0125	477.0125
05*		476.5250	476.5250	25		477.0250	477.0250
	45*	-	476.5375		65	477.0375	477.0375
06*		476.5500	476.5500	26		477.0500	477.0500
	46*	-	476.5625		66	477.0625	477.0625
07*		476.5750	476.5750	27		477.0750	477.0750
	47*	-	476.5875		67	477.0875	477.0875
08*		476.6000	476.6000	28		477.1000	477.1000
	48*	-	476.6125		68	477.1125	477.1125
9		476.6250	476.6250	29		477.1250	477.1250
	49	476.6375	476.6375		69	477.1375	477.1375
10		476.6500	476.6500	30		477.1500	477.1500
	50	476.6625	476.6625		70	477.1625	477.1625
11		476.6750	476.6750	31*		477.1750	477.1750
	51	476.6875	476.6875		71*	477.1875	-
12		476.7000	476.7000	32*		477.2000	477.2000
	52	476.7125	476.7125		72*	477.2125	-
13		476.7250	476.7250	33*		477.2250	477.2250
	53	476.7375	476.7375		73*	477.2375	-
14		476.7500	476.7500	34*		477.2500	477.2500
	54	476.7625	476.7625		74*	477.2625	-
15		476.7750	476.7750	35*		477.2750	477.2750
	55	476.7875	476.7875		75*	477.2875	-
16		476.8000	476.8000	36*		477.3000	477.3000
	56	476.8125	476.8125		76*	477.3125	-
17		476.8250	476.8250	37*		477.3250	477.3250
	57	476.8375	476.8375		77*	477.3375	-
18		476.8500	476.8500	38*		477.3500	477.3500
	58	476.8625	476.8625		78*	477.3625	-
19		476.8750	476.8750	39		477.3750	477.3750
	59	476.8875	476.8875		79	477.3875	477.3875
20		476.9000	476.9000	40		477.4000	477.4000
	60	476.9125	476.9125		80	477.4125	477.4125

Channel Frequency Table

* The primary use for these channels is repeater operation using 750 kHz offset. Channels 1-8 and 41-48 inclusive are used for mobile reception and channels 31-38 and 71-78 for mobile transmission. In addition, any designated repeater channel may be used for simplex operation in areas where it is not used for repeater operation.

† Speech telephony shall be inhibited on these channels.

‡ At the time of production, Channels 61, 62 and 63 are guard channels and are not available for use.

Channel 5 and 35 (paired for Duplex repeaters) are reserved as emergency channels and should be used only in an emergency.

CTCSS and DCS will not operate on channels 5 and 35.

A list of currently authorised channels can be obtained from the ACMA website in Australia and the MED website in New Zealand. Channel 11 is a calling channel generally used to call others and channel 40 is the customary road vehicle channel.

Once contact is established on the calling channel, both stations should move to another unused "SIMPLEX" channel to allow others to use the calling channel.

Channels 22 and 23 are for Telemetry and Telecommand use, voice communications are not allowed on these channels by law.

Channel 9 and above are the best choices for general use in Simplex mode.

TROUBLE SHOOTING GUIDE

PROBLEM	GUIDE
No power or radio switches off after a short time	<ol style="list-style-type: none"> 1: Check charger and batteries are installed correctly. 2: Clean battery contacts (Important!). 3: Replace batteries with fully charged or new batteries. 4: Battery capacity poor: battery defective or at end of life, replace batteries.
I cannot communicate with other group members	<ol style="list-style-type: none"> 1: Verify, that the channel frequency and the CTCSS settings are the same on all radios. 2: The other group members are not within radio coverage.
Audio cutting in and out at receivers end.	<ol style="list-style-type: none"> 1: Too weak signal-too far away. 2: External mic defective? Please contact Oricom Support.
Too many transmissions heard on my channel.	<ol style="list-style-type: none"> 1: Another group is using the same channel number -change channel

Customer Support

If you have any problems setting up or using this product, you will find useful tips and information in the Troubleshooting section of this user guide as well as “Frequently Asked Questions” on our website www.oricom.com.au.

If you have further questions about using the product after reviewing the resources above or would like to purchase replacement parts or accessories, please call our Customer Support Team.

Important

Please retain your purchase receipt and attach to the back page of this user guide as you will need to produce this if warranty service is required.

Express Warranty (Australia)

This Express Warranty is provided by Oricom International Pty Ltd ABN 46 086 116 369, Unit 1, 4 Sovereign Place, South Windsor NSW 2756, herein after referred to as “Oricom”.

Oricom warrants that the product is free from defects in materials or workmanship during the Express Warranty Period. This Express Warranty does not extend to any product from which the serial number has been removed or was purchased outside of Australia.

The benefits of this Express Warranty are in addition to other rights and remedies you may have under the Australian Consumer Law. Our goods come with guarantees that cannot be excluded under the Australian Consumer Law. You are entitled to a replacement or refund for a major failure and compensation for any other reasonably foreseeable loss or damage. You are also entitled to have the goods repaired or replaced if the goods fail to be of acceptable quality and the failure does not amount to a major failure. In the event of a minor failure, Oricom reserves the right to choose to repair or replace the product.

The Express Warranty Period will be a period of 3 years beginning on the date of purchase of the product evidenced by your dated sales receipt. You are required to provide proof of purchase as a condition of receiving Express Warranty services.

Express Warranty (Australia)

You are entitled to a replacement product or repair of the product at our discretion according to the terms and conditions of this document if your product is found to be faulty within the Express Warranty Period. This Express Warranty extends to the original purchaser only and is not transferable.

Products distributed by Oricom are manufactured using new materials or new and used materials equivalent to new in performance and reliability. Spare parts may be new or equivalent to new. Spare parts are warranted to be free from defects in material or workmanship for thirty (30) days or for the remainder of the Express Warranty Period of the Oricom branded product in which they are installed, whichever is longer. During the Express Warranty Period, Oricom will where possible repair and if not replace the faulty product or part thereof. All component parts removed under this Express Warranty become the property of Oricom. In the unlikely event that your Oricom product has a recurring failure, Oricom may always, subject to the Competition and Consumer Act 2010, at its discretion, elect to provide you with a replacement product of its choosing that is at least equivalent to your product in performance.

No change to the conditions of this Express Warranty is valid unless it is made in writing and signed by an authorised representative of Oricom.

Oricom will not be liable under this Express Warranty, and to the extent permitted by law will not be liable for any defect, loss, damage or injury arising out of or in connection with a:

1. Failure by you to adhere to the warnings and follow the instructions set out in this user guide for the proper installation and use of the product;
2. Willful misconduct or deliberate misuse by you of the product;
3. Any external cause beyond our control, including but not limited to power failure, lightning or over voltage; or
4. Modification to the product or services carried out on the product by anyone other than Oricom or Oricom's authorised service provider.

How to make a claim under your Express Warranty in Australia

Oricom has a simple warranty process for you to follow:

- Please call or email our Customer Support Team, 02 4574 8888 or support@oricom.com.au.
- A Customer Support Team member will verify after troubleshooting with you if your product qualifies under warranty. If so, they will give you a Product Return Authorisation number.
- We will then email a Return Authorisation form and a Repair Notice (if necessary), together with instructions on how to return the product for warranty service.

Please note that if a Customer Support Team member advises that your product does not qualify for return, this warranty does not apply to your product. Products that are authorised to be returned to Oricom in Australia must include all of the following:

Express Warranty (Australia)

- A completed Return Authorisation form
- A copy of your Proof of Purchase (please keep your original copy)
- The faulty product, including all accessories.

Send the approved returns to:

Oricom International Pty Ltd

Locked Bag 658

South Windsor NSW 2756 Australia

Please note that this Express Warranty excludes expenses incurred by you in returning any faulty product to us. You must arrange and pay any expenses incurred (including postage, delivery, freight, transportation or insurance of the product) to return the faulty product to us, however, we will arrange delivery of the repaired or replaced faulty product to you.

Important Information

Repair Notice

Please be aware that the repair of your products may result in the loss of any user-generated data (such as stored telephone numbers, text messages and contact information). Please ensure that you have made a copy of any data saved on your product before sending for repair. Please also be aware that products presented for repair may be replaced by refurbished products or parts of the same type rather than being repaired.

