



Premium DECT Digital Baby Monitor Secure 510



User Guide



Important Safety Information

- It is very important that you read the User Guide carefully as it contains detailed information you will need to get the most from your Oricom Baby Monitor. If you have any issues setting up or using your Oricom Baby monitor please call our Customer support team. Our dedicated local team are more likely to be able to help you than the retailer where you made your purchase.
- Your ORICOM Baby Monitor is designed to be an aid and should not be used as a substitute for responsible and proper adult supervision of a child.
- The Baby Monitor has been designed to provide some added reassurance in the form of sound transmission for those times when you are not in the same room as your baby provided you always stay within hearing range of the baby monitor during use. Your Baby Monitor is not a medical device, nor a device to prevent cases of Sudden Infant Death Syndrome (SID'S) or "cot death", and you should not rely on it for your baby's wellbeing. It is important that you regularly check on your baby personally.
- Make sure the Baby unit, Parent unit and mains adaptor cables are kept out of reach of your baby and other young children at all times, at least one metre away.
- Never place the baby unit or parent unit inside your baby's cot, bed or playpen.
- Never cover the Parent or baby units with clothes, towels or blankets or any other item. Never use or place your Parent or Baby unit in or near moisture or water (e.g. near bath or pool). Immersing in water could cause electric shock and even death.

- The installation location plays an important role in ensuring proper operation. Therefore, maintain a distance of at least one meter from other electronic equipment, such as microwave ovens or hi-fi devices, otherwise they could cause interference. During continual use the Baby unit power adaptors may become warm to the touch. This is normal and should not be a concern.

Warning



Risk of suffocation!

Keep all packaging materials and protective foils out of reach of children.

Do not place the AC Adaptor cable in a high "wear and tear" location. Never use a frayed or compromised cord.

Battery safety

- Batteries represent a hazard to health and the environment!
- They contain toxic, ecologically hazardous heavy metals. Do not dispose of batteries in a fire as they may explode. Dispose of batteries according to local regulations, never in your household rubbish.
- Do not dismantle, cut, open, crush, bend, puncture, or shred cells or batteries. If a battery leaks, do not let the battery liquid touch skin or eyes. If this happens, immediately flush the affected areas with water, and seek medical assistance.
- Do not modify, remanufacture, attempt to insert foreign objects into the battery, or immerse or expose it to water or other liquids. Batteries may explode if damaged.

6

IMPORTANT SAFETY INFORMATION

- Use only the batteries supplied with the product. Improper use, or use of unapproved batteries may present a risk of fire, explosion, or other hazard, and may invalidate any approval or warranty.
- If you believe the batteries are damaged, remove product from the charger and stop using the product. Contact Oricom for assistance. Never use a damaged battery.

Disposal

Always dispose of your products at the end of their life in accordance with your local waste disposal requirements. **Packaging materials** all cardboard and paper packaging should be recycled in accordance with your local council waste regulations.

This User Guide provides you with all the information you need to get the most from your Oricom Digital Baby Monitor.

Please read this guide carefully and keep it for future reference.

Need help?

If you need assistance setting up or using your Oricom Digital Baby Monitor call our Support team on 1300 889 785. If you would like any additional or replacement rechargeable batteries for the parent unit (Part No.BAT1300MAH) order online at www.oricom.com.au.

Our dedicated advisors are more likely to be able to help you than the retailer where you made your purchase.

Alternatively, you may find the answer in the 'Help' section at the back of this guide.

Additional answers to Frequently Asked Questions are also available from www.oricom.com.au

Got everything?

- Baby unit
- Parent unit
- 2 x AA NiMH 1300mAh rechargeable batteries for Parent unit (pre-installed)
- Parent unit charger
- 2 x power adapters

Parent unit

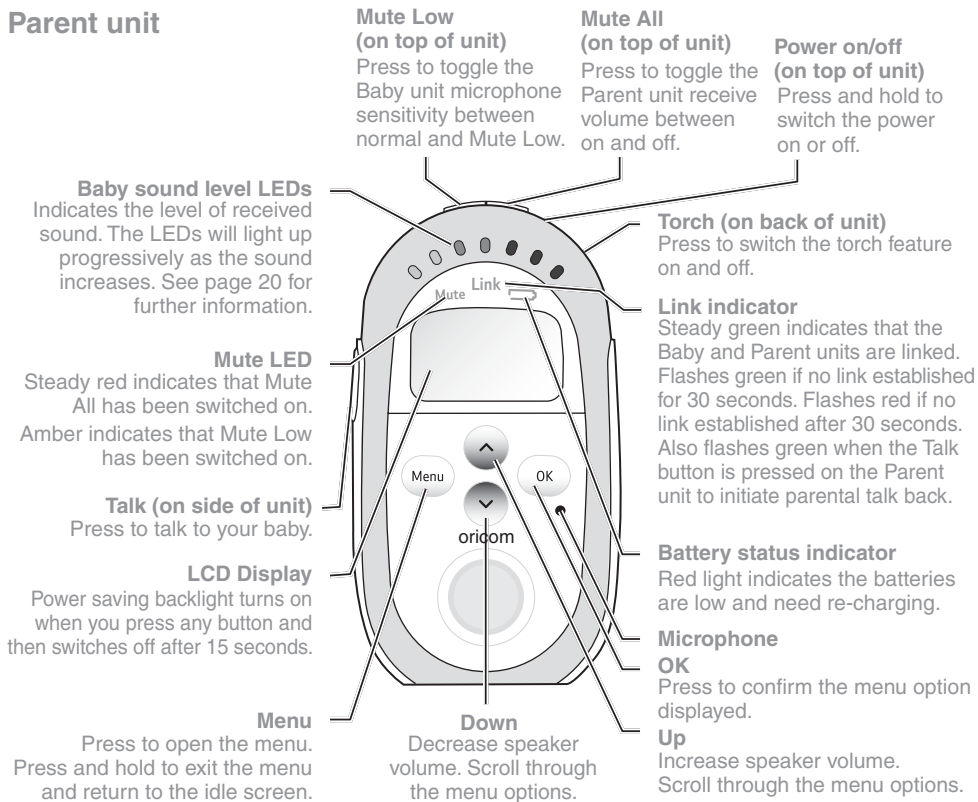

Parent unit display icons

Menu options:









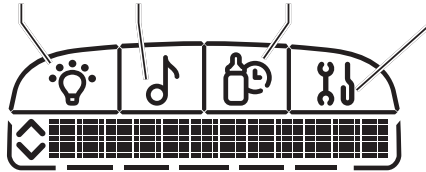







Nightlight

Music

Feed Timer

Setup



- | | | | |
|--|---|---|---|
|  | Temperature alert (vibrate on) |  | Feed timer on (vibrate on) |
|  | Temperature alert (vibrate off) |  | Feed timer on (vibrate off) |
|  | Nightlight is on |  | Full charge (75-100%) |
|  | Music is playing |  | Medium charge (51-74%) |
|  | Displays the temperature as measured at the Baby unit |  | Low charge (25-50%) |
|  | Crying alert (vibrate on) |  | Empty (8-24%) |
|  | Crying alert (vibrate off) |  | Flashing (0-7%) |
| | |  | Icon will scroll when charging |
| | |  | Indicates when you can scroll up or down through the menu options |

10 ORICOM DIGITAL BABY MONITOR

Parent unit charger

Front

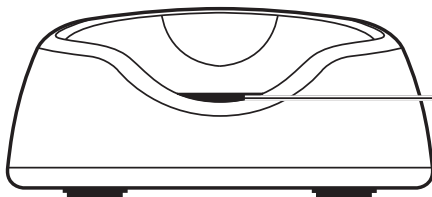

Charging light

Red when the Parent unit is correctly placed on the charger.

Back

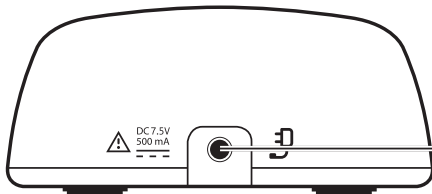

Power socket

For connection to the mains power socket via the power adaptor cable supplied.

Baby unit

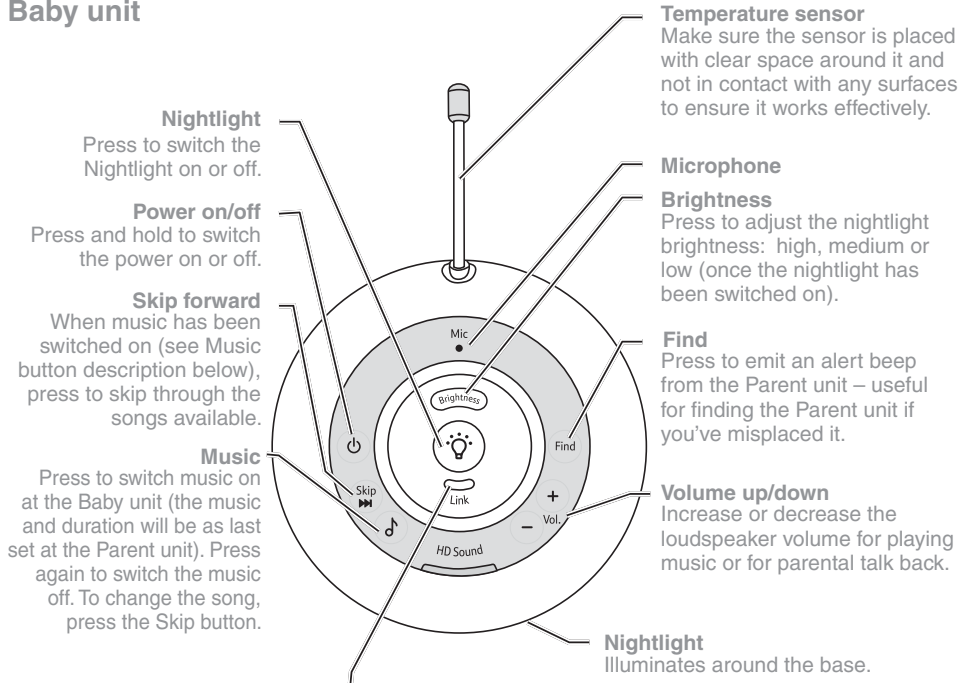

Nightlight

Press to switch the Nightlight on or off.

Power on/off

Press and hold to switch the power on or off.

Skip forward

When music has been switched on (see Music button description below), press to skip through the songs available.

Music

Press to switch music on at the Baby unit (the music and duration will be as last set at the Parent unit). Press again to switch the music off. To change the song, press the Skip button.

Temperature sensor

Make sure the sensor is placed with clear space around it and not in contact with any surfaces to ensure it works effectively.

Microphone

Brightness

Press to adjust the nightlight brightness: high, medium or low (once the nightlight has been switched on).

Find

Press to emit an alert beep from the Parent unit – useful for finding the Parent unit if you've misplaced it.

Volume up/down

Increase or decrease the loudspeaker volume for playing music or for parental talk back.

Nightlight

Illuminates around the base.

Link indicator

Steady green indicates that the Baby and Parent units are linked. Flashes green if no link established for 30 seconds. Flashes red if no link established after 30 seconds. Also flashes green when the Talk button is pressed on the Parent unit to initiate parental talk back.

12 ORICOM DIGITAL BABY MONITOR

Back of Baby unit

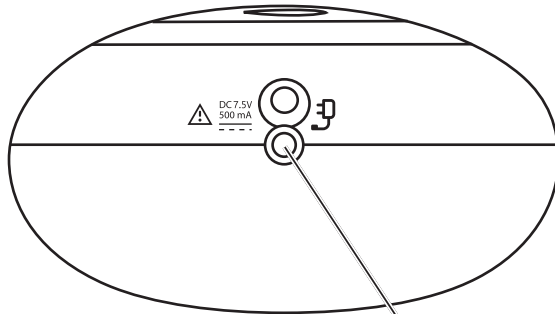

Power socket

For connection to the mains power socket via the power adaptor cable supplied.

Parent unit menu map

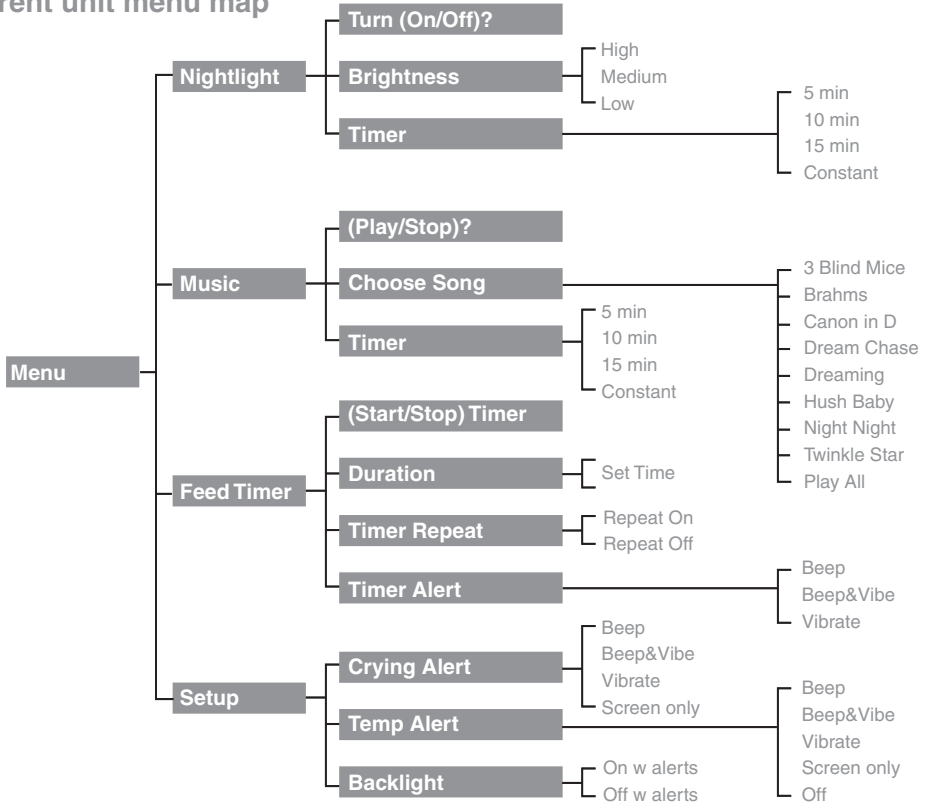

14 SETTING UP

Parent unit

1. Plug one of the power adaptor cables into the socket marked  on the back of the Parent unit charger and plug the other end into the mains power wall socket and switch the power on.

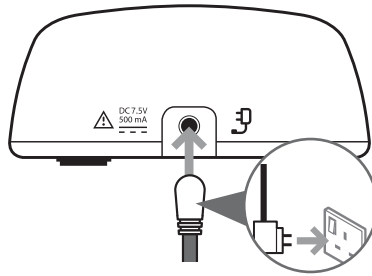

2. Activate the batteries by pulling the plastic tab away from the back of the Parent unit.

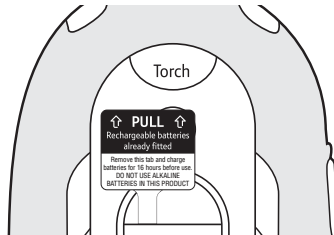

- Place the Parent unit into the charger. The red charging light will illuminate on the charger and the battery icon will start scrolling on the Parent until display to indicate that the batteries are being charged.

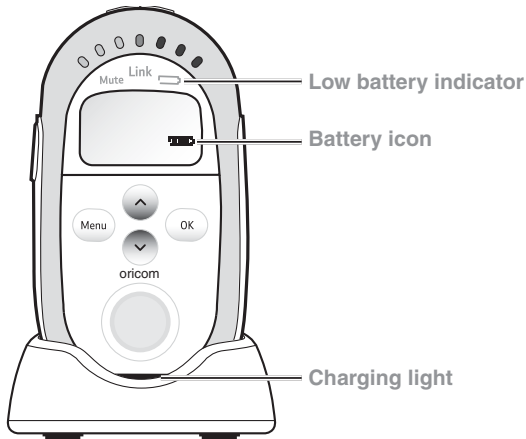



Leave the batteries to charge for 16 hours to reach maximum charge. When the batteries are fully charged the battery icon on the display will show a full charge .

Warning



Only use the power adaptors supplied. Using incorrect power may permanently damage your product. This product is designed for indoor use only.

Switch on and link the Parent and Baby units

1. Press and hold the  button on the Baby unit for 1 second. The nightlight will briefly illuminate and then the green Link indicator will flash.
2. Press and hold the  button on the Parent unit until all the LEDs on the unit briefly illuminate. The green Link indicator will flash and the display will show **I'm Linking**.

Warning



Never use non-rechargeable batteries in the Parent unit. Only use the recommended type – 2 x AA NiMH 1300mAh batteries. Using other types could permanently damage the unit. Charge the batteries as instructed in this user guide. The Parent unit can still be used when it is in the charger.

Removing the batteries

If you ever need to remove the batteries, simply slide open the battery compartment cover and use the ribbon to eject the batteries.

Once the units are Linked the green Link light on the top of the Parent unit and the green LED on the Baby unit will stop flashing and remain a steady green. The units are now ready to use.

IMPORTANT



The link confirmation between the two units is vital for use so they can communicate. If the link between the units is broken at any time, the Link indicators on both units will flash green as they try to search for each other. The Parent unit displays **I'm Linking...** After 30 seconds, if the link is still broken, the Baby and Parent units Link indicators will flash red. The Parent unit display will show **No Link** and you will hear an alert signal.

18 SETTING UP

If the link is broken:

- check that the mains power is plugged in and switched on at the Baby unit
- check that both units are switched on
- check that the batteries are charged in the Parent unit
- check that the Parent and Baby units are within range of each other (in ideal conditions the range is up to 300 metres outdoors and 50m indoors)

Positioning your units

The Baby unit should ideally be within 1m-2m of your baby for best performance.

If you place the Parent and Baby units too close together you will hear a high pitched noise, this is normal. The units are designed to be located at a distance from one another, e.g. in separate rooms.

Switching on/off

Switch the Baby unit on

1. Press and hold the  button for 1 second. The nightlight will briefly illuminate and then the green Link indicator will flash until it links with the Parent unit. Once linked the green Link indicator will remain on.

Switch the Parent unit on

1. Press and hold the  button on the Parent unit until all the LEDs briefly illuminate. The green Link indicator will flash and the display will show **I'm Linking**.

Once the units are linked the green Link indicators on the Parent and Baby units will stop flashing and remain a steady green. The units are now ready to use.

Switch the Baby unit off

1. Press and hold the  button on the Baby unit. The green Link indicator will switch off.

Switch the Parent unit off

1. Press and hold the  button on the Parent unit until an audible alert sounds. The green Link indicator will switch off and the display will go blank.

Baby sound level LED indicators

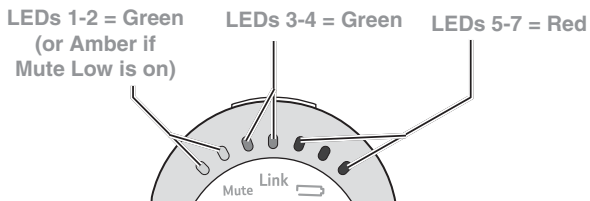

The seven LEDs across the top of the Parent unit light up to indicate the level of sound being received from the Baby unit. The LEDs light up progressively as the sound increases.

LEDs 1-2 light up Green (or Amber if Mute Low is on, see page 18) when sounds of 57dB and 63dB are received.

LEDs 3-4 light up Green when sounds of 69dB and 75dB are received.

LEDs 5-7 light up Red when sounds of 83dB, 89dB or 95dB are received.

Equivalent sound level examples:



60dB-70dB = normal conversation

75dB = loud conversation

83-95dB = loud traffic noise





Adjust the loudspeaker volume

At the Parent unit:

1. Press  or  to select the required level. The first press will show the current setting. There are 5 volume levels and off (Mute). The volume level will be shown on the display at each press, e.g. Level 3 is shown as **Volume ■■■**. If you wish to switch the volume off, keep pressing  until the display shows **Volume Off**. The Mute All indicator will illuminate.

At the Baby unit:

There are 5 volume settings.

1. When Music is being played or Talk back is in progress from the Parent unit, press the  or  button to adjust the volume.
2. If no music or Talk back is in use, pressing the  or  buttons will adjust the volume and a beep will sound at the appropriate volume level set.

If you try and set the volume higher or lower than the 5 settings available on either unit you will hear an error tone.

Setting the Parent unit to **Volume Off** is the equivalent of switching the Mute All feature on. See page 22 for more information on Mute All.

The default loudspeaker volume on both units is Level 3.

Mute All feature – Parent unit only

The Mute All feature prevents any sound coming from the Parent unit loudspeaker. With Mute All on you can still monitor your baby using the Baby sound level LED indicators (page 20) and the Crying Alert (page 34).

1. To switch Mute All on, press the  button located on the top of the unit. The Mute indicator will illuminated red.
2. To switch Mute All off, press the  button again. The red Mute indicator will switch off.

Be careful not to accidentally switch the torch feature on because Mute All is automatically switched on when the Torch is switched on.



Setting the Parent unit loudspeaker volume to **Volume off** is the equivalent of switching the Mute All feature on.

Mute Low

For discreet operation when you do not wish to hear any low level sounds, you can still monitor your baby using the Baby sound level LED indicators (page 20). When Mute Low is switched on, any sounds from the Baby unit to the Parent unit will be muted unless a sound is made above a set level. The set level are sounds that are louder than the first two green LEDs would register, as described in 'Baby sound level LED indicators on page 20.

If the  or  buttons are pressed whilst Mute All or Mute Low has been set then Mute All or Low will be switched off and the loudspeaker volume will return to Level 3 automatically.



If the Parent unit receives sound up to the level of the first two LEDs then they will turn amber but no sound will be heard, if the sound rises above this level then the unit will un-mute so you can hear the sounds.

1. To switch Mute Low on, press the  button located on the top of the Parent unit. The Mute indicator will turn amber.
2. To switch Mute Low off, press the  button again. The amber indicator will switch off.

Once the Mute Low sound threshold has been exceeded, baby sounds will be able to be heard for a further six seconds even if they do not reach the Mute Low threshold.

Talk Back



You can use the Parent unit Talk Back feature as a one way intercom to comfort and reassure your baby. By speaking into the Parent unit your baby will hear your voice from the Baby unit. Please note that when using Talk Back you will not be able to hear your baby until you release the  button.

1. Press and hold down the  button on the Parent unit to speak to your baby. Whilst the  button is depressed the display will show **Talk** and the green Link indicators will flash on both units.

Talk Back

You will be able to activate Talk Back mode even if other functions have been activated at the Baby unit like Music playback or Nightlight on.



Press  or  to adjust the Talk Back volume level of the Baby unit loudspeaker.

Do not press the  button when the Baby unit and Parent unit are positioned in the same room. High-pitch noise will be generated if the  button is pressed when Baby unit and Parent unit are close to each other or within 3 metres distance.

When using Talk Back, hold the Parent unit approximately 30cm in front of your mouth when talking to baby.

Find

You can press the  button on the Baby unit to make the Parent unit sound an alert to help you find it if it's been misplaced. If the Parent unit loudspeaker volume had been Muted (or set to volume off), the volume level will be reset to the default setting of Level 3.

1. Press  on the Baby unit. The paging alert will sound at the Parent unit and the display will show **Here I am!**
2. To stop the alert, press any button on the Parent unit or press the  button again on the Baby unit. If no button is pressed after 2 minutes then the alert will automatically stop.

Torch









The Parent unit has a high intensity white LED torch that can be used when the Parent unit is switched on or off.

1. Press the  button located on the back of the Parent unit to switch the Torch on and off.

When the Torch is switched on it will automatically switch Mute All on as well. If you then press the  button Mute will be disabled and the Torch will remain on. When the Torch is switched off, the previous Mute setting will be restored (**No Mute, Mute All** or **Mute Low**).

The Parent unit menu

The  button on the Parent unit can be used to select and change settings on the Baby unit without having to risk disturbing your baby. You can access the settings by:



1. Press  then press  or  to scroll through the menu options shown on the top of the display. Press  when the option you want is displayed.
2. The first sub menu option will be displayed, press  to scroll through the options. The  (arrows) indicate when you can scroll either up or down. Press  when the option you want is displayed.
3. To exit the menu at any time, press  briefly and step back one menu level at a time, or press and hold  to return to the idle screen. If no buttons are pressed for 10 seconds whilst accessing the menu, the display will return to idle and any unsaved changes will be lost.

Nightlight



You can set a comforting nightlight on the Baby unit. There are 3 brightness levels to choose from and you can set a period of time for the nightlight to illuminate.

The Baby unit must be switched on for the nightlight to work, but need not be linked to the Parent unit.

Switch nightlight on/off and select brightness level using the Baby unit

1. To switch on, press the  button.
2. TPress  repeatedly to select the brightness level.
2. To switch off, press .

Switch nightlight on/off using the Parent unit

1. To switch on, press the **Menu** button. **Nightlight** is displayed, press **OK**.
2. **Turn On?** is displayed, press **OK**. **Light On** will briefly be displayed, then the  icon.
3. To switch off, press **Menu**. **Nightlight** is displayed, press **OK**. **Turn Off?** is displayed, press **OK**. **Light Off** will briefly be displayed and then the  icon will disappear.

Select the nightlight brightness level using the Parent unit

1. Press **Menu**. **Nightlight** is displayed, press **OK**.
2. Press **▼** to display **Brightness** and press **OK**.
3. Press **▲** or **▼** to display either **Low**, **Medium** or **High** and press **OK** to select. The display will show **Saved** briefly and you'll hear a confirmation tone.

The default setting is **Medium**.

Set the nightlight timer

1. Press **Menu**. **Nightlight** is displayed, press **OK**.
2. Press **▼** to display **Timer** and press **OK**.
3. Press **▲** or **▼** to display either **5 min**, **10 min**, **15 min** or **Constant** and press **OK** to select.

The display will show **Saved** briefly and you'll hear a confirmation tone.



The default setting is Constant.

Play music from the Baby unit

The Baby unit has eight songs that can be played to gently soothe your baby. You can select one song to play repeatedly or select the Play All option for a medley of all eight songs. The songs can be set to play in a loop for 5, 10 or 15 minutes or you can leave them playing constantly.

The default music setting is Play All songs Constantly.











Turn music on/off using the Baby unit

1. To turn the music on, press the  button. The most recently selected song will start playing at the time period last selected using the Parent unit.
2. Press the  button repeatedly to change the pre-selected song.
3. To turn the music off, press the  button.

Adjust the volume of the music using the  or  buttons on the Baby unit.

If music is played at greater than volume 3, the Crying Alert may activate if Mute All is used.

Turn music on/off using the Parent unit

1. To turn the music on, press . **Nightlight** is displayed, press  to display Music and press .
2. **Play?** is displayed, press . The display will briefly show **Music On**, then the name of the song and the  icon and the song will start to play on the Baby unit.
3. To turn the music off, press  , press  to display Music and press . The display will show **Stop?**, press . The display will show **Music Off**, the  icon will disappear and the music will stop playing on the Baby unit.

Choose a song to play using the Parent unit

1. Press **Menu**. **Nightlight** is displayed, press **↓** to display **Music** and press **OK**.
2. **Play?** is displayed, press **↓** to display **Choose Song** and press **OK**.
3. Use the **↑** and **↓** buttons to scroll through the eight song titles and **Play All**. Press **OK** when the option you want is displayed. The display will show **Saved** briefly and you'll hear a confirmation tone.

The eight song choices are: 3 Blind Mice, Brahms, Canon in D, Dream Chase, Dreaming, Hush Baby, Night Night and Twinkle Star.

Play All will play a medley of all eight songs.









Set a play time for music

1. Press **Menu**. **Nightlight** is displayed, press **↓** to display **Music** and press **OK**.
2. **Play?** is displayed, press **↓** until **Timer** is displayed and press **OK**.
3. Use the **↑** and **↓** buttons to scroll through the options: **5 min**, **10 min**, **15 min** or **Constant** and press **OK** when the option you want is displayed. The display will show **Saved** briefly and you'll hear a confirmation tone.

Feed Timer

You can set a Feed Timer on the Parent unit to act as a countdown timer that will alert you when you next need to feed your baby. You have a choice of alert types (beep, beep & vibrate and vibrate) and you can set the timer to repeat itself once the alert sounds.

Set the feed timer countdown duration





1. Press . **Nightlight** is displayed, press  until **Feed Timer** is displayed and press .
2. **Start?** is displayed, press  to display **Duration** and press .
3. The display will show **02h:00m** (or the currently set timer). Use the  and  buttons to select the first digit and press . Repeat this procedure for each digit and press . The display will show **Saved** and you'll hear a confirmation beep.

The timer can be set from 1 minute to 99 hours 59 minutes.

The feed timer default countdown duration is set at 02:00 (2 hours).





If the Parent unit is switched off, the feed timer countdown will be cancelled and you will need to start it again when the unit is switched back on. The duration, alert type and repeat settings will still be retained.

Start the feed timer countdown









1. Press . **Nightlight** is displayed, press  until **Feed Timer** is displayed and press .
2. **Start?** is displayed, press . The display will briefly show **Timer On** and then the timer will be shown counting down the seconds from the time you set.

When the timer has finished counting down to **00:00** you will hear an alert beep and the timer digits and  icon will flash. Press any button on the Parent unit to stop the alert. If you do not stop the alert it will automatically stop after 2 minutes (or it will start again if Timer Repeat has been set).

Cancel the feed timer countdown

1. Press . **Nightlight** is displayed, press  until **Feed Timer** is displayed and press .
2. **Stop?** is displayed, press . The display will briefly show **Timer Off**, the timer will then disappear and the display will return to idle.









Switch timer repeat option on or off

1. Press . **Nightlight** is displayed, press  until **Feed Timer** is displayed and press .
2. **Start?** is displayed, press  until **Timer Repeat** is displayed and press .
3. Use the  and  buttons to display either **Repeat On** or **Repeat Off** and press  to select. The display will show **Saved** and you will hear a confirmation beep.

When **Repeat On** has been set, the feed timer countdown will start again once the alert has sounded if it is not switched off.

The default setting is **Repeat On**.

Select the type of feed timer alert

1. Press . **Nightlight** is displayed, press  until **Feed Timer** is displayed and press .
2. **Start?** is displayed, press  until **Alert** is displayed and press .
3. Use the  and  buttons to display either **Beep**, **Beep&Vibe** or **Vibrate** and press  to select. The display will show **Saved** and you will hear a confirmation beep.

Feed timer alert options:

Beep = Parent unit will emit an alert beep only.

Beep&Vibe = Parent unit will emit an alert beep and vibrate.

Vibrate = Parent unit will vibrate only.

The default setting is **Beep&Vibe**.

IMPORTANT

The temperature sensor used in this Oricom Digital Baby Monitor is intended as a guide, to provide parents with an indication of the room temperature in which the Baby unit has been placed.

It is designed to operate within an approximate tolerance of +/- 1°C and is not intended to be as accurate as some medical devices. Please note that your own temperature reference e.g. your central heating thermostat may not be as accurate, possibly due to tolerances and positioning of the thermostat in relation to the Baby Monitor sensor.

Healthcare professionals advise that the ideal temperature for your baby's room is between 16 °C and 20°C.

Your Parent unit has a built-in mechanism to prevent repeated annoying audible alerts if the room temperature hovers around an alerting threshold.









Temperature monitor

There is a temperature sensor on the Baby unit to constantly monitor the temperature in your baby's room and you'll be alerted if it gets too hot, too warm or too cold. The Parent unit will vibrate, sound an alert beep and display a message on the screen. The alerts on the Parent unit can be changed, see page 34. The temperature will be constantly shown on the Parent unit display in °C. To stop an alert beep, press any button on the Parent unit.

Temperature monitor indicators

Temperature	On the Parent unit
Below 16°C	Display shows Too Cold
16 – 20°C	
21 – 24°C	Display shows Too Warm
Over 24°C	Display shows Too Hot

Select the type of temperature alert

1. Press . **Nightlight** is displayed, press  until **SetUp** is displayed and press .
2. **Crying Alert** is displayed, press  until **Temp Alert** is displayed and press .
3. Use the  and  buttons to display either **Beep**, **Beep&Vibe**, **Vibrate**, **Screen Only** or **Off** and press  to select. The display will show **Saved** and you will hear a confirmation beep.

To stop an alert beep, press any button on the Parent unit.

Temperature alert options

Beep = Parent unit will beep. 🔔 icon will flash.

Beep&Vibe = Parent unit will beep and vibrate. 🔔 icon will flash.

Vibrate = Parent unit will vibrate. 🔔 icon will flash.

Screen Only = 🔔 icon will flash.

Off = No alerts. 🔔 icon will not be displayed.

All of the above alerts will also display the appropriate message: **Too Hot, Too Warm or Too Cold**.

Pre-set temperature alert range

The Baby unit comes with pre-set maximum and minimum temperatures. If the temperature falls below or goes above the setting an alert will sound on the Parent unit and the display will show **Too Cold** or **Too Hot** as appropriate. The temperature alert pre-set temperatures are below 16°C and above 24°C. Alerts will be repeated if the temperature creeps by 2°C into an alerting range.







The default setting is **Beep&Vibrate**.

Crying alert

The crying alert will only be activated if Mute All has been switched on (or if the Parent unit volume has been switched to volume off), see page 22 for information on the Mute All feature.

With Mute All switched on, if your baby starts to cry you will not be able to hear the cries, but if the cries sound above a certain level i.e. if they reach 83dBa, which is the 1st red Baby sound level LED, then the Parent unit will activate the crying alert. The default crying alert is for the Parent unit to vibrate and emit an audible beep but you can select a different alert if you want to.

Select the type of crying alert

1. Press . **Nightlight** is displayed, press  until **SetUp** is displayed and press .
2. **Crying Alert** is displayed, press .
3. Use the  and  buttons to display either **Beep**, **Beep&Vibe**, **Vibrate** or **Screen Only** and press  to select. The display will show **Saved** and you will hear a confirmation beep.

To stop an alert beep, press any button on the Parent unit.

Crying alert options

Beep = Parent unit will beep, **Crying Alert** will be displayed and  icon will flash.

Beep&Vibe = Parent unit will beep and vibrate. **Crying Alert** will be displayed and  icon will flash.









Vibrate = Parent unit will vibrate only (no alert beep will sound). **Crying Alert** will be displayed and the  icon will flash.

Screen Only = **Crying Alert** will be displayed and the  icon will flash.

The default setting is **Beep&Vibrate**.

Backlight

You can select whether or not the LCD backlight comes on when an alert is activated. When the backlight comes on it will stay on for 15 seconds. The default setting is On.

1. Press . **Nightlight** is displayed, press  until **SetUp** is displayed and press .
2. **Crying Alert** is displayed, press  until **Backlight** is displayed and press .
3. Use the  and  buttons to display either **On w alerts** or **Off w alerts** and press  to select. The display will show **Saved** and you will hear a confirmation beep.

List of tones

Your Baby Monitor unit can produce various tones. They have the following meaning:

Tone	Meaning
Single tone	Confirmation tone e.g. setting saved.
Double tone (fast)	Error tone e.g. max volume reached when adjusting volume.
Double tone (slow)	User alert e.g. crying alert, paging alert etc.
Triple tone (fast)	System alert e.g. link lost, battery low etc.

User Alert tones can be silenced by pressing any button on the Parent unit. System Alerts can be silenced for a 5 minute period by pressing any button on the Parent unit.

Reset the units

Resetting either units will return the settings at that unit back to its default settings.

Resetting the units is only advisable if you are experiencing difficulties with your product. It is a useful feature that ensures your Baby Monitor is returned to its new “out of the box” settings.

Reset the Parent unit

1. Within 3 seconds of the Parent unit being switched on, press and hold the  button for at least 10 seconds. The display will show **Reset** for 2 seconds during the reset and then you will hear a confirmation beep once the reset has been performed.

Reset the Baby unit

1. Within 3 seconds of the Baby unit being switched on, press the  button for at least 10 seconds.

You will hear a confirmation beep once the reset has been performed.

38 TROUBLESHOOTING

Should you experience difficulties operating the SC510 please refer to the troubleshooting guide below. If you still experience difficulties please contact Oricom Customer Support on 1300 889 785 for assistance.

Troubleshooting

Problems	Solutions
Link light does not come on	<ul style="list-style-type: none">- Check that both the Baby and Parent units are switched on.- Check that the batteries in the Parent unit are correctly installed and that they are charged.- Check that the mains power is plugged in and switched on at the Baby unit.- Check that the units are within range of each other.
Link light is flashing green	<ul style="list-style-type: none">- If you have pressed  to use the Talk Back feature, the Link light will flash to indicate one-way communication between the units.- The units are searching for a communication link.- Check units are within range of one another.- Check both units are turned on.
Link indicator is flashing red	<ul style="list-style-type: none">- The link between your units is broken. You will also hear an alert on the Parent unit to let you know there is no communication between the units. If this happens, check that the mains power (or batteries) is correctly connected and that the units are within range of one another. See page 17 for instructions on linking the units.

<p>Battery low on Parent unit</p>	<ul style="list-style-type: none"> – Put the Parent unit back on the charger to charge. – Place Parent unit back on the charger as frequently as possible or ideally leave it on the charger to ensure the batteries remain charged. – To shorten the charging time you can turn the Parent unit off if it is not being used while it is charging.
<p>Parent unit remains silent or very quiet</p>	<ul style="list-style-type: none"> – You may have set the volume too low, see page 22 to increase the volume. – You may have switched a Mute feature on, see pages 22.
<p>You can hear a high pitched noise</p>	<ul style="list-style-type: none"> – The units might be too close to each other. – The volume setting might be too high, see page 21.
<p>Talk back feature is not working</p>	<ul style="list-style-type: none"> – Check that the volume is loud enough at the Baby unit, see page 21. – Check the units are linked, see page 17.

Customer Support

If you have any problems setting up or using this product you will find useful tips and information in the Troubleshooting section of this user guide as well as “Frequently Asked Questions” on our website www.oricom.com.au.

If you have further questions about using the product after reviewing the resources above or would like to purchase replacement parts or accessories please call our Customer Support Team. Our dedicated local support team are more likely to be able to help you than the retailer where you made your purchase.

Important

Please retain your purchase receipt and attach to the back page of this user guide as you will need to produce this if warranty service is required. Take a few moments to register your product online: www.oricom.com.au

How to make a claim under Warranty in Australia

Oricom has a simple warranty process for you to follow:

- Please call or email our Customer Support Team, contact details follow.
- A Customer Support Team member will verify after troubleshooting with you if your product qualifies under warranty. If so, they will give you a Product Return Authorisation number.
- We will then email or fax a Return Authorisation form and a Repair Notice (if necessary), together with instructions on how to return the goods for warranty service.

Please note that if a Customer Support Team member advises that your product does not qualify for return, this warranty does not apply to your product.

Products that are authorised to be returned to Oricom in Australia must include all of the following:

- A completed Return Authorisation form
- A copy of your Proof of Purchase (please keep your original copy)
- The faulty product, including all accessories, Send the approved returns to:
Oricom International Pty Ltd
Locked Bag 658
South Windsor NSW 2756 Australia

Please note that this warranty excludes expenses incurred by you in returning any faulty product to us. You must arrange and pay any expenses incurred (including postage, delivery, freight, transportation or insurance of the product) to return the faulty product to us, however, we will arrange delivery of the repaired or replaced faulty product to you.

Important Information

Repair Notice

Please be aware that the repair of your goods may result in the loss of any user-generated data (such as stored telephone numbers, text messages and contact information). Please ensure that you have made a copy of any data saved on your goods before sending for repair.

Please also be aware that goods presented for repair may be replaced by refurbished goods or parts of the same type rather than being repaired.

Warranty Information (Australia)

This Warranty is provided by Oricom International Pty Ltd ABN 46 086 116 369, Unit 1, 4 Sovereign Place, South Windsor NSW 2756, herein after referred to as “Oricom”.

Oricom makes no other warranties or conditions, express or implied, including as to acceptable quality and fitness for a particular purpose, except as stated in this Warranty. Any implied warranties that may be imposed by law are limited in duration to the Warranty Period.

Oricom warrants that the product is free from defects in materials or workmanship during the Warranty Period. This Warranty does not extend to any product from which the serial number has been removed or was purchased outside of Australia.

This warranty in no way affects your statutory warranty rights under the Competition and Consumer Act 2010 or any other similar legislation.

The Warranty Period will be 3 years from the date of purchase of the product evidenced by your dated sales receipt. You are required to provide proof of purchase as a condition of receiving warranty services.

You are entitled to a replacement product or repair of the product according to the terms and conditions of this document if your product is found to be faulty within the Warranty Period. This Warranty extends to the original purchaser only and is not transferable. Rechargeable battery cells and rechargeable battery packs (if supplied) with this product are covered under this warranty for a period of 90 days.

44 WARRANTY

Products distributed by Oricom are manufactured using new materials or new and used materials equivalent to new in performance and reliability. Spare parts may be new or equivalent to new. Spare parts are warranted to be free from defects in material or workmanship for thirty (30) days or for the remainder of the Warranty Period of the Oricom branded product in which they are installed, whichever is longer. During the Warranty Period, Oricom will where possible repair and if not replace the faulty product or part thereof. All component parts removed under this Warranty become the property of Oricom. In the unlikely event that your Oricom product has a recurring failure, Oricom may, subject to the Competition and Consumer Act 2010, at its discretion, elect to provide you with a replacement product of its choosing that is at least equivalent to your product in performance.

Oricom does not warrant that the operation of the product will be uninterrupted or error free.

Oricom is not responsible for damage that occurs as a result of your failure to follow the instructions that came with the product. These terms and conditions together with any specific terms and conditions contained in the user guide to the product purchased constitute the complete and exclusive agreement between you and Oricom regarding the product.

No change to the conditions of this Warranty is valid unless it is made in writing and signed by an authorised representative of Oricom.

Oricom will not be in breach of a warranty expressly set out in this User Guide or under the Competition and Consumer Act 2010 and excludes any liability for damages or any other remedy arising under any other legislation or the common law if the damage occurs as a result of:

1. failure by you to adhere to the warnings and follow the instructions set out in this user guide for the proper installation and use of the product;
2. negligence on your part or misuse by you of the product;
3. an uncontrollable external cause which results in the product not functioning including but not limited to power failure, lightning or over voltage; and
4. modification to the product or services carried out on the product by anyone other than Oricom or Oricom's authorised service provider.

Oricom will not be liable for any damages caused by the product or the failure of the product to perform, including any lost profits or savings or special, incidental or consequential damages. Oricom is not liable for any claim made by a third party or made by you on behalf of a third party. This limitation of liability applies whether damages are sought, or a claim made, under this Warranty or as a tort claim (including negligence and strict product liability), a contract claim or any other claim. However, this limitation of liability will not apply to claims for personal injury. Nothing in this Warranty excludes, restricts or modifies any condition, warranty, right or remedy which pursuant to the Competition and Consumer Act 2010 applies to this Warranty and which may not be so excluded, restricted or modified. For warranties that cannot be excluded, restricted or modified, Oricom limits the remedies available to those specified in the relevant legislation.

Oricom products come with guarantees that cannot be excluded under the Australian Consumer Law. You are entitled to a replacement or refund for a major failure and compensation for any other reasonably foreseeable loss or damage. You are also entitled to have the goods repaired or replaced if the goods fail to be of acceptable quality and the failure does not amount to a major failure.

Contact Details for Oricom support and Warranty claims in Australia

Oricom International Pty Ltd
Locked Bag 658
South Windsor, NSW 2756
Australia

Email: support@oricom.com.au
Phone: 1300 889 785
(Monday to Friday 8am to 6pm AEST)
Web: www.oricom.com.au
Fax: (02) 4574 8898

Contact details for Oricom Support and Warranty Claims in New Zealand

Email: support@oricom.co.nz
Phone: 0800 674 266
(Monday to Friday 10am to 8pm NZST)
Web: www.oricom.co.nz



Ref: 25102011