

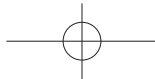

# DECT Digital Baby Monitor Secure 310

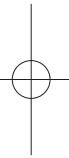

**User Guide**

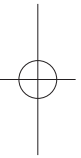



# TABLE OF CONTENTS

**IMPORTANT SAFETY INFORMATION** ..... 4

**GETTING STARTED** ..... 7

**ORICOM DIGITAL BABY MONITOR** ..... 8

**SETTING UP** ..... 12

**USING YOUR DIGITAL BABY MONITOR** ..... 17

**TROUBLESHOOTING** ..... 25

**CUSTOMER SUPPORT** ..... 27

**WARRANTY** ..... 28

**Need Help?**

If you need assistance setting up or using your Oricom product now or in the future, call Oricom Support.

Australia                      1300 889 785  
   www.oricom.com.au  
   Mon-Fri 8am – 6pm AEST

New Zealand                    0800 67 42 66  
   www.oricom.co.nz  
   Mon-Fri 10am – 8pm NZST



## 4 IMPORTANT SAFETY INFORMATION

### Important Safety Information

- It is very important that you read the User Guide carefully as it contains detailed information you will need to get the most from your Oricom Baby Monitor. If you have any issues setting up or using your Oricom Baby monitor please call our Customer support team. Our dedicated local team are more likely to be able to help you than the retailer where you made your purchase.
- Your ORICOM Baby Monitor is designed to be an aid and should not be used as a substitute for responsible and proper adult supervision of a child.
- The Baby Monitor has been designed to provide some added reassurance in the form of sound transmission for those times when you are not in the same room as your baby provided you always stay within hearing range of the baby monitor during use. Your Baby Monitor is not a medical device, nor a device to prevent cases of Sudden Infant Death Syndrome (SID'S) or "cot death", and you should not rely on it for your baby's wellbeing. It is important that you regularly check on your baby personally.
- Make sure the Baby unit, Parent unit and mains adaptor cables are kept out of reach of your baby and other young children at all times, at least one metre away.
- Never place the baby unit or parent unit inside your baby's cot, bed or playpen.
- Never cover the Parent or baby units with clothes, towels or blankets or any other item. Never use or place your Parent or Baby unit in or near moisture or water (e.g. near bath or pool). Immersing in water could cause electric shock and even death.



# IMPORTANT SAFETY INFORMATION

5

- The installation location plays an important role in ensuring proper operation. Therefore, maintain a distance of at least one meter from other electronic equipment, such as microwave ovens or hi-fi devices, otherwise they could cause interference. During continual use the Baby unit power adaptors may become warm to the touch. This is normal and should not be a concern.



## Warning

Risk of suffocation!

Keep all packaging materials and protective foils out of reach of children.

Do not place the AC Adaptor cable in a high "wear and tear" location. Never use a frayed or compromised cord.

## Battery safety

- Batteries represent a hazard to health and the environment!
- They contain toxic, ecologically hazardous heavy metals. Do not dispose of batteries in a fire as they may explode. Dispose of batteries according to local regulations, never in your household rubbish.
- Do not dismantle, cut, open, crush, bend, puncture, or shred cells or batteries. If a battery leaks, do not let the battery liquid touch skin or eyes. If this happens, immediately flush the affected areas with water, and seek medical assistance.
- Do not modify, remanufacture, attempt to insert foreign objects into the battery, or immerse or expose it to water or other liquids. Batteries may explode if damaged.



## 6 IMPORTANT SAFETY INFORMATION

- Use only the batteries supplied with the product. Improper use, or use of unapproved batteries may present a risk of fire, explosion, or other hazard, and may invalidate any approval or warranty.
- If you believe the batteries are damaged, remove product from the charger and stop using the product. Contact Oricom for assistance. Never use a damaged battery.

### Disposal

Always dispose of your products at the end of their life in accordance with your local waste disposal requirements. **Packaging materials** all cardboard and paper packaging should be recycled in accordance with your local council waste regulations.



# GETTING STARTED 7

**This User Guide provides you with all the information you need to get the most from your Oricom Digital Baby Monitor.**

**Please read this guide carefully and keep it for future reference.**

Need help?

If you need assistance setting up or using your Oricom Digital Baby Monitor call our Support team on 1300 889 785. If you would like any additional or replacement rechargeable batteries for the parent unit (Part No.BAT1300MAH) order online at [www.oricom.com.au](http://www.oricom.com.au).

Our dedicated advisors are more likely to be able to help you than the retailer where you made your purchase.

Alternatively, you may find the answer in the 'Help' section at the back of this guide.

Additional answers to Frequently Asked Questions are also available from [www.oricom.com.au](http://www.oricom.com.au)

Got everything?

- Baby unit
- Parent unit
- 2 x AA NiMH 1300mAh rechargeable batteries for Parent unit (pre-installed)
- Parent unit charger
- 2 x power adaptors

# 8

# ORICOM DIGITAL BABY MONITOR

## Parent unit

### Lanyard attach point (top of unit)

You can loop a lanyard (not supplied) through here.

### Mute All (on top of unit)

Press to toggle the Parent unit receive volume between on and off.

### Mute Low (on top of unit)

Press to toggle the Baby unit microphone sensitivity between normal and Mute Low.

### Talk (on side of unit)

Press to talk to your baby.

### Mute LED

Steady red indicates that Mute All has been switched on.

Amber indicates that Mute Low has been switched on.

### - Vol.

Decrease speaker volume.

### Power on/off (on top of unit)

Press and hold to switch the power on or off.

### Baby sound level LEDs

Indicates the level of received sound. The LEDs will light up progressively as the sound increases. See page 18 for further information.

### Low battery status indicator

Red light indicates the batteries are low and need re-charging.

### Link status indicator

Steady green indicates that the Baby and Parent units are linked. Flashes green if not linked for the first 30 seconds. Flashes red if not linked for longer than 30 seconds. Also flashes green when the Talk button is pressed on the Parent unit to initiate parental talk back.

### Microphone

### + Vol.

Increase speaker volume.

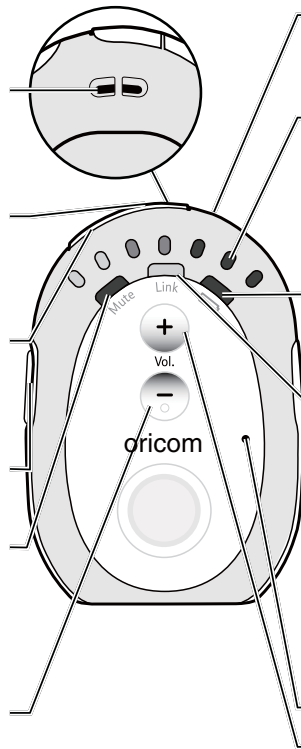





# ORICOM DIGITAL BABY MONITOR

9

## Parent unit charger

Front

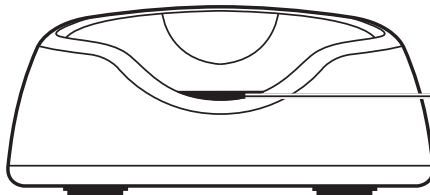

### Charging light

Red when the Parent unit is correctly placed on the charger.

Back

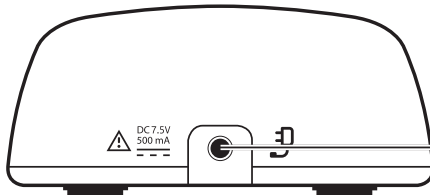

DC 7.5V  
500 mA



### Power socket

For connection to the mains power socket via the power adaptor cable supplied.



# 10 ORICOM DIGITAL BABY MONITOR

## Baby unit

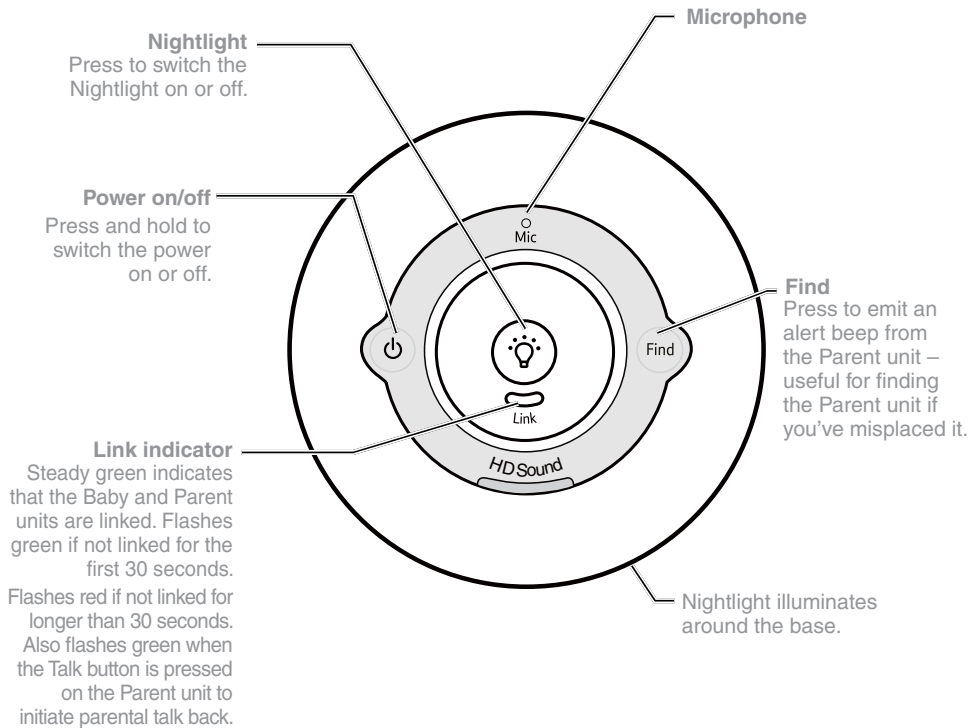



# ORICOM DIGITAL BABY MONITOR 11

## Back of Baby unit

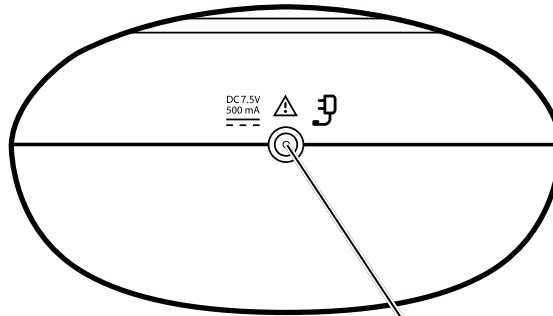

### **Power socket**

For connection to the mains power socket via the power adaptor cable supplied.

## 12 SETTING UP

### Parent unit

1. Plug one of the power adaptor cables into the socket marked  on the back of the Parent unit charger and plug the other end into the mains power wall socket and switch the power on.

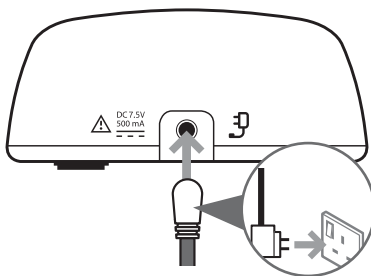

2. Activate the batteries by pulling the plastic tab away from the back of the Parent unit.

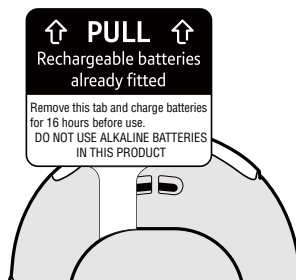

- Place the Parent unit into the charger. The red charging light will illuminate on the charger and the battery icon will start scrolling on the Parent until display to indicate that the batteries are being charged.

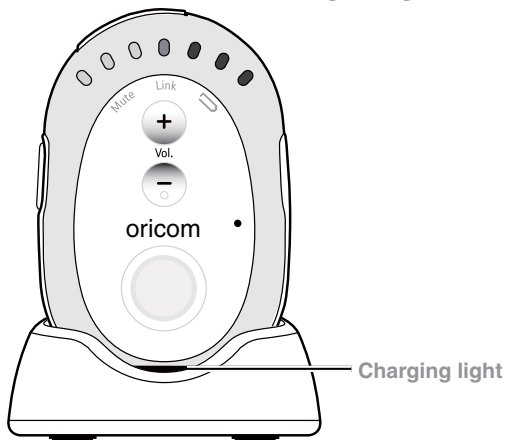

Leave the batteries to charge for 16 hours to reach maximum charge.



## Warning

Only use the power adaptors supplied. Using incorrect power may permanently damage your product. This product is designed for indoor use only.

## 14 SETTING UP

### Battery performance

Rechargeable batteries in the Parent unit will last up to 20 hours in normal use. Please note that new batteries do not reach full capacity until they have been in normal use for several days.

The charge capacity of rechargeable batteries will reduce with time as they wear out, so reducing the performance time of the Parent unit. Eventually they will need to be replaced. New batteries can be obtained from the Oricom Digital Baby Monitor Support Centre 1300 889 785.

The Parent unit rechargeable batteries will lose charge over a period of time, even if switched off.

### Battery low warning – Parent unit

When the batteries are low – approximately within 1 hour of running out – the Parent unit will emit a low battery alert and the low battery indicator on the unit will turn red. Place the Parent unit back on the charger to charge the batteries. To speed up the charging process turn the Parent unit off when charging if it's not being used.



You can still use your Parent unit to monitor your baby even when the batteries are low, provided it remains in the charger cradle to re-charge the batteries.

### Baby unit

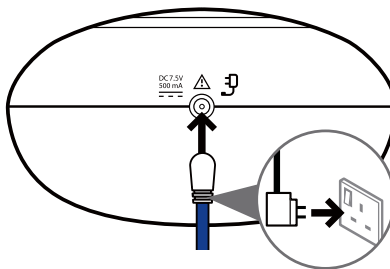
1. Plug the remaining power adaptor cable into the socket marked  on the back of the Baby unit and plug the other end into the mains power and switch on.



## Switch on and link the Parent and Baby units

1. Press and hold the  button on the Baby unit for 1 second. The nightlight will briefly illuminate and then the green Link indicator will flash.
2. Press and hold the  button on the Parent unit until all the LEDs on the unit briefly illuminate. The green Link indicator will flash.

### Warning



Never use non-rechargeable batteries in the Parent unit. Only use the recommended type – 2 x AA NiMH 1300mAh batteries. Using other types could permanently damage the unit. Charge the batteries as instructed in this user guide. The Parent unit can still be used when it is in the charger.

### Removing the batteries

If you ever need to remove the batteries, simply slide open the battery compartment cover and use the ribbon to eject the batteries.

Once the units are Linked the green Link light on the top of the Parent unit and the green LED on the Baby unit will stop flashing and remain a steady green. The units are now ready to use.

### IMPORTANT



The link confirmation between the two units is vital for use so they can communicate. If the link between the units is broken at any time, the Link indicators on the Parent and Baby units will flash green as they try to search for each other. After 30 seconds, if the link is still broken they will flash red and you will also hear an alert signal from the Parent unit.



## 16 SETTING UP

If the link is broken:

- check that the mains power is plugged in and switched on at the Baby unit
- check that both units are switched on
- check that the batteries are charged in the Parent unit
- check that the Parent and Baby units are within range of each other (in ideal conditions the range is up to 300 metres outdoors and 50m indoors)

### **Positioning your units**

The Baby unit should ideally be within 1m-2m of your baby for best performance.

If you place the Parent and Baby units too close together you will hear a high pitched noise, this is normal. The units are designed to be located at a distance from one another, e.g. in separate rooms.







# USING YOUR DIGITAL BABY MONITOR 17

## Switching on/off

### Switch the Baby unit on

1. Press and hold the  button for 1 second. The nightlight will briefly illuminate and then the green Link indicator will flash until it links with the Parent unit. Once linked the green Link indicator will remain on.

### Switch the Parent unit on

1. Press and hold the  button on the Parent unit until all the LEDs briefly illuminate. The green Link indicator will flash.  
Once the units are linked the green Link indicators on the Parent and Baby units will stop flashing and remain a steady green. The units are now ready to use.

### Switch the Baby unit off

1. Press and hold the  button on the Baby unit. The green Link indicator will switch off.

### Switch the Parent unit off

1. Press and hold the  button on the Parent unit until an audible alert sounds. The green Link indicator will switch off and the display will switch off.

# 18 USING YOUR DIGITAL BABY MONITOR

## Baby sound level LED indicators

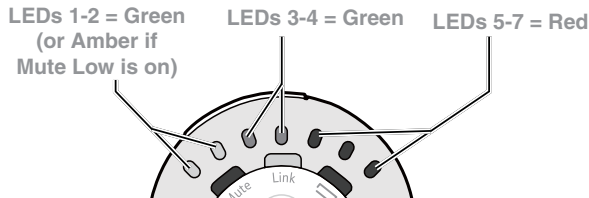

The seven LEDs across the top of the Parent unit light up to indicate the level of sound being received from the Baby unit. The LEDs light up progressively as the sound increases.

**LEDs 1-2** light up Green (or Amber if Mute Low is on, see page 18) when sounds of 57dB and 63dB are received.

**LEDs 3-4** light up Green when sounds of 69dB and 75dB are received.

**LEDs 5-7** light up Red when sounds of 83dB, 89dB or 95dB are received.

### Equivalent sound level examples:

60dB-70dB = normal conversation

75dB = loud conversation

83-95dB = loud traffic noise





# USING YOUR DIGITAL BABY MONITOR 19

## Adjust the Parent unit loudspeaker volume

There are 5 volume levels and off (Mute).

The default loudspeaker volume is Level 3.

1. Press  or  to select the required level. You will hear a difference in volume as you keep pressing the button(s).

If you wish to switch the volume off, keep pressing  until the Mute LED turns red (Mute All) or press the  button.

If you try and set the volume higher or lower than the 5 settings available on either unit you will hear an error tone.



Setting the Parent unit volume to Off is the equivalent of switching the Mute All feature on. See page 20 for more information on Mute All.



## 20 USING YOUR DIGITAL BABY MONITOR

### Mute All feature – Parent unit only

The Mute All feature prevents any sound coming from the Parent unit loudspeaker. With Mute All on you can still monitor your baby using the Baby sound level LED indicators (page 18) and the Crying Alert (below).

1. To switch Mute All on, press the  button located on the top of the unit. The Mute indicator will illuminated red.
2. To switch Mute All off, press the  button again. The red Mute indicator will switch off.

Setting the Parent unit loudspeaker volume to **Volume off** is the equivalent of switching the Mute All feature on.

### Crying alert

The crying alert will only be activated if Mute All has been switched on (or if the Parent unit loudspeaker volume has been switched off), see above for information on the Mute All feature.

With Mute All switched on, if your baby starts to cry you will not be able to hear the cries but if the cries sound above a certain level i.e. if they reach 83dB, which is the 1st red Baby sound level LED, then the Parent unit will emit an audible beep. The crying alert is a 'user alert' as described on page 23.

### Mute Low

For discreet operation when you do not wish to hear any low level sounds, you can still monitor your baby using the Baby sound level LED indicators (page 18).



# USING YOUR DIGITAL BABY MONITOR 21

When Mute Low is switched on, any sounds from the Baby unit to the Parent unit will be muted unless a sound is made above a set level. The set level are sounds that are louder than the first two green LEDs would register, as described in 'Baby sound level LED indicators' on page 18.

If the **Talk** or **Find** buttons are pressed whilst Mute All or Mute Low has been set then Mute All or Low will be switched off and the loudspeaker volume will return to Level 3 automatically.

If the Parent unit receives sound up to the level of the first two LEDs then they will turn amber but no sound will be heard, if the sound rises above this level then the unit will un-mute so you can hear the sounds.

1. To switch Mute Low on, press the **Mute Low** button located on the top of the Parent unit. The Mute indicator will turn amber.
2. To switch Mute Low off, press the **Mute Low** button again. The amber indicator will switch off.

Once the Mute Low sound threshold has been exceeded, baby sounds will be able to be heard for a further six seconds even if they do not reach the Mute Low threshold.

## Talk Back

You can use the Parent unit Talk Back feature as a one way intercom to comfort and reassure your baby. By speaking into the Parent unit your baby will hear your voice from the Baby unit. Please note that when using Talk Back you will not be able to hear your baby until you release the **Talk** button.

1. Press and hold down the **Talk** button on the Parent unit to speak to your baby. Whilst the **Talk** button is depressed the green Link indicators will flash on both units.



## 22 USING YOUR DIGITAL BABY MONITOR



You will be able to activate Talk Back mode even if other functions have been activated at the Baby unit like Music playback or Nightlight on.

Do not press the **Talk** button when the Baby unit and Parent unit are positioned in the same room. High-pitch noise will be generated if the **Talk** button is pressed when Baby unit and Parent unit are close to each other or within 3 metres distance. When using Talk Back, hold the Parent unit approximately 30cm in front of your mouth when talking to baby.

### Nightlight

You can set a comforting nightlight on the Baby unit.

Switch Baby unit nightlight on/off

1. To switch on, press the  button.
2. To switch off, press the  button.

The Baby unit must be switched on for the nightlight to work, but need not be linked to the Parent unit.

### Find

You can press the **Find** button on the Baby unit to make the Parent unit sound an alert to help you find it if it's been misplaced. If the Parent unit loudspeaker volume had been Muted (or set to volume off), the volume level will be reset to the default setting of Level 3.

1. Press **Find** on the Baby unit. The paging alert will sound at the Parent unit.
2. To stop the alert, press any button on the Parent unit or press the **Find** button again on the Baby unit. If no button is pressed after 2 minutes then the alert will automatically stop.

# USING YOUR DIGITAL BABY MONITOR 23

## List of tones

Your Baby Monitor unit can produce various tones. They have the following meaning:

Tone	Meaning
Single tone	Confirmation tone e.g. setting saved.
Double tone (fast)	Error tone e.g. max volume reached when adjusting volume.
Double tone (slow)	User alert e.g. crying alert, paging alert etc.
Triple tone (fast)	System alert e.g. link lost, battery low etc.

User Alert tones can be silenced by pressing any button on the Parent unit.

System Alerts can be silenced for a 5 minute period by pressing any button on the Parent unit.

## Reset the units

Resetting either units will return the settings at that unit back to its default settings.

Resetting the units is only advisable if you are experiencing difficulties with your product. It is a useful feature that ensures your Baby Monitor is returned to its new “out of the box” settings.



## 24 USING YOUR DIGITAL BABY MONITOR

### Reset the Parent unit

1. Within 3 seconds of the Parent unit being switched on, press and hold the  button for at least 10 seconds. The display will show **Reset** for 2 seconds during the reset and then you will hear a confirmation beep once the reset has been performed.

### Reset the Baby unit

1. Within 3 seconds of the Baby unit being switched on, press the  button for at least 10 seconds. You will hear a confirmation beep once the reset has been performed.





# TROUBLESHOOTING 25

Should you experience difficulties operating the SC310 please refer to the troubleshooting guide below. If you still experience difficulties please contact Oricom Customer Support on 1300 889 785 for assistance.

## Troubleshooting

Problems	Solutions
Link light does not come on	<ul style="list-style-type: none"><li>- Check that both the Baby and Parent units are switched on.</li><li>- Check that the batteries in the Parent unit are correctly installed and that they are charged.</li><li>- Check that the mains power is plugged in and switched on at the Baby unit.</li><li>- Check that the units are within range of each other.</li></ul>
Link light is flashing green	<ul style="list-style-type: none"><li>- If you have pressed  to use the Talk Back feature, the Link light will flash to indicate one-way communication between the units.</li><li>- The units are searching for a communication link.</li><li>- Check units are within range of one another.</li><li>- Check both units are turned on.</li></ul>
Link indicator is flashing red	<ul style="list-style-type: none"><li>- The link between your units is broken. You will also hear an alert on the Parent unit to let you know there is no communication between the units. If this happens, check that the mains power (or batteries) is correctly connected and that the units are within range of one another. See page 15 for instructions on linking the units.</li></ul>



## 26 TROUBLESHOOTING

Battery low on  
Parent unit

- Put the Parent unit back on the charger to charge.
- Place Parent unit back on the charger as frequently as possible or ideally leave it on the charger to ensure the batteries remain charged.
- To shorten the charging time you can turn the Parent unit off if it is not being used while it is charging.

Parent unit remains  
silent or very quiet

- You may have set the volume too low, see page 19 to increase the volume.
- You may have switched a Mute feature on, see pages 20-21.

You can hear a high  
pitched noise

- The units might be too close to each other.
- The volume setting might be too high, see page 19.

Talk back feature is  
not working

- Check the units are linked.



# CUSTOMER SUPPORT 27

## Customer Support

If you have any problems setting up or using this product you will find useful tips and information in the Troubleshooting section of this user guide as well as “Frequently Asked Questions” on our website [www.oricom.com.au](http://www.oricom.com.au).

If you have further questions about using the product after reviewing the resources above or would like to purchase replacement parts or accessories please call our Customer Support Team. Our dedicated local support team are more likely to be able to help you than the retailer where you made your purchase.

## Important

Please retain your purchase receipt and attach to the back page of this user guide as you will need to produce this if warranty service is required. Take a few moments to register your product online: [www.oricom.com.au](http://www.oricom.com.au)



## 28 WARRANTY

### How to make a claim under Warranty in Australia

Oricom has a simple warranty process for you to follow:

- Please call or email our Customer Support Team, contact details follow.
- A Customer Support Team member will verify after troubleshooting with you if your product qualifies under warranty. If so, they will give you a Product Return Authorisation number.
- We will then email or fax a Return Authorisation form and a Repair Notice (if necessary), together with instructions on how to return the goods for warranty service.

Please note that if a Customer Support Team member advises that your product does not qualify for return, this warranty does not apply to your product.

Products that are authorised to be returned to Oricom in Australia must include all of the following:

- A completed Return Authorisation form
- A copy of your Proof of Purchase (please keep your original copy)
- The faulty product, including all accessories.

Send the approved returns to:

Oricom International Pty Ltd  
Locked Bag 658  
South Windsor NSW 2756 Australia

Please note that this warranty excludes expenses incurred by you in returning any faulty product to us. You must arrange and pay any expenses incurred (including postage, delivery, freight, transportation or insurance of the product) to return the faulty product to us, however, we will arrange delivery of the repaired or replaced faulty product to you.



# WARRANTY 29

## Important Information

### Repair Notice

Please be aware that the repair of your goods may result in the loss of any user-generated data (such as stored telephone numbers, text messages and contact information). Please ensure that you have made a copy of any data saved on your goods before sending for repair. Please also be aware that goods presented for repair may be replaced by refurbished goods or parts of the same type rather than being repaired.

### Warranty Information (Australia)

This Warranty is provided by Oricom International Pty Ltd ABN 46 086 116 369, Unit 1, 4 Sovereign Place, South Windsor NSW 2756, herein after referred to as “Oricom”.

Oricom makes no other warranties or conditions, express or implied, including as to acceptable quality and fitness for a particular purpose, except as stated in this Warranty.

Any implied warranties that may be imposed by law are limited in duration to the Warranty Period.

Oricom warrants that the product is free from defects in materials or workmanship during the Warranty Period. This Warranty does not extend to any product from which the serial number has been removed or was purchased outside of Australia.

This warranty in no way affects your statutory warranty rights under the Competition and Consumer Act 2010 or any other similar legislation.

The Warranty Period will be 3 years from the date of purchase of the product evidenced by your dated sales receipt. You are required to provide proof of purchase as a condition of receiving warranty services.



## 30 WARRANTY

You are entitled to a replacement product or repair of the product according to the terms and conditions of this document if your product is found to be faulty within the Warranty Period. This Warranty extends to the original purchaser only and is not transferable.

Rechargeable battery cells and rechargeable battery packs (if supplied) with this product are covered under this warranty for a period of 90 days.

Products distributed by Oricom are manufactured using new materials or new and used materials equivalent to new in performance and reliability. Spare parts may be new or equivalent to new. Spare parts are warranted to be free from defects in material or workmanship for thirty (30) days or for the remainder of the Warranty Period of the Oricom branded product in which they are installed, whichever is longer. During the Warranty Period, Oricom will where possible repair and if not replace the faulty product or part thereof. All component parts removed under this Warranty become the property of Oricom. In the unlikely event that your Oricom product has a recurring failure, Oricom may, subject to the Competition and Consumer Act 2010, at its discretion, elect to provide you with a replacement product of its choosing that is at least equivalent to your product in performance. Oricom does not warrant that the operation of the product will be uninterrupted or error free.

Oricom is not responsible for damage that occurs as a result of your failure to follow the instructions that came with the product. These terms and conditions together with any specific terms and conditions contained in the user guide to the product purchased constitute the complete and exclusive agreement between you and Oricom regarding the product.

No change to the conditions of this Warranty is valid unless it is made in writing and signed by an authorised representative of Oricom.



# WARRANTY 31

Oricom will not be in breach of a warranty expressly set out in this User Guide or under the Competition and Consumer Act 2010 and excludes any liability for damages or any other remedy arising under any other legislation or the common law if the damage occurs as a result of:

1. failure by you to adhere to the warnings and follow the instructions set out in this user guide for the proper installation and use of the product;
2. negligence on your part or misuse by you of the product;
3. an uncontrollable external cause which results in the product not functioning including but not limited to power failure, lightning or over voltage; and
4. modification to the product or services carried out on the product by anyone other than Oricom or Oricom's authorised service provider.

Oricom will not be liable for any damages caused by the product or the failure of the product to perform, including any lost profits or savings or special, incidental or consequential damages. Oricom is not liable for any claim made by a third party or made by you on behalf of a third party. This limitation of liability applies whether damages are sought, or a claim made, under this Warranty or as a tort claim (including negligence and strict product liability), a contract claim or any other claim. However, this limitation of liability will not apply to claims for personal injury. Nothing in this Warranty excludes, restricts or modifies any condition, warranty, right or remedy which pursuant to the Competition and Consumer Act 2010 applies to this Warranty and which may not be so excluded, restricted or modified. For warranties that cannot be excluded, restricted or modified, Oricom limits the remedies available to those specified in the relevant legislation.

Oricom products come with guarantees that cannot be excluded under the Australian Consumer Law. You are entitled to a replacement or refund for a major failure and compensation for any other reasonably foreseeable loss or damage. You are also entitled to have the goods repaired or replaced if the goods fail to be of acceptable quality and the failure does not amount to a major failure.



### **Contact details for Oricom support and warranty claims in Australia**

Oricom International Pty Ltd  
Locked Bag 658  
South Windsor, NSW 2756  
Australia

Email: [support@oricom.com.au](mailto:support@oricom.com.au)  
Phone: 1300 889 785  
(Monday to Friday 8am to 6pm AEST)  
Web: [www.oricom.com.au](http://www.oricom.com.au)  
Fax: (02) 4574 8898

### **Contact details for Oricom support and warranty claims in New Zealand**

Email: [support@oricom.co.nz](mailto:support@oricom.co.nz)  
Phone: 0800 674 266  
(Monday to Friday 10am to 8pm NZST)  
Web: [www.oricom.co.nz](http://www.oricom.co.nz)



Ref: 25102011