

cleanoz™ easy

nasal aspirator kit

MB002

USER MANUAL

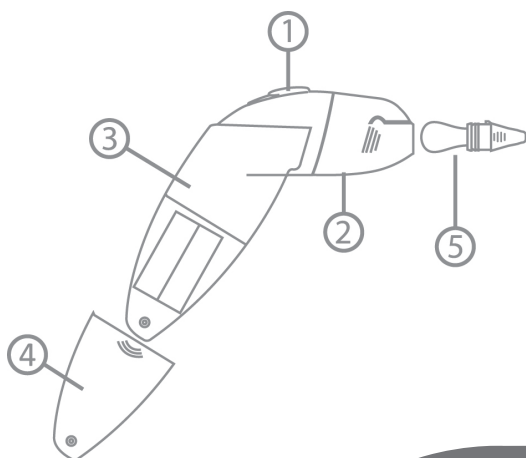

GENERAL DESCRIPTION

- ① On-Off Switch
- ② Venting hole on transparent tank
- ③ Main unit and transparent tank
- ④ Battery door
- ⑤ Disposable reservoir nozzle tip

Keep this user guide for future reference.

Always retain your proof of purchase in case of warranty service.

Oricom CLEANOZ™ Easy nasal aspirator, electric is included as a medical device on the Australian Register of Therapeutic Goods (ARTG No. 229897) and is intended to enable clearing of excessive mucus from nasal passages of an infant/child to facilitate easier breathing. Intended for domestic use only.

ALWAYS READ THE LABEL AND USER GUIDE. USE ONLY AS DIRECTED.

IF SYMPTOMS PERSIST SEE YOUR DOCTOR/ HEALTHCARE PROFESSIONAL.

IMPORTANT SAFEGUARDS

READ ALL INSTRUCTIONS BEFORE USE



Basic safety precautions should always be followed when using any electrical device, especially intended for baby's care.

Use this product only for its intended purpose as described in this manual and follow all instructions.

PRECAUTIONS

- 
- 1) CLEANOZ™ is not a toy. CLEANOZ™ must be used by adults only after reading this manual.
 - 2) Keep CLEANOZ™ and nozzle pieces out of children's reach.
 - 3) CLEANOZ™ is designed for domestic use, only to aspirate baby's nasal secretions.
 - 4) CLEANOZ™ is designed for intermittent use, (15 seconds/minute max).
Using the appliance without a nozzle piece or keeping the switch on when the reservoir bag is full will exhaust batteries prematurely.
 - 5) Before using CLEANOZ™ make sure that all parts are correctly assembled.
 - 6) Respect the expiration date of the disposable reservoir nozzle pieces.
 - 7) Do not attempt to disassemble the nose cleaner unit or the nozzle pieces.
 - 8) Do not strike, bend or drop the unit.
 - 9) Use only CLEANOZ™ single use reservoir nozzle pieces for CLEANOZ™ MB002TIPS. They are designed to be used only with CLEANOZ™ MB002.
 - 10) The reservoir nozzle piece is not sterile.
 - 11) Do not use or store the unit or the disposable nozzle pieces under the following conditions:
 - * Hot locations such as the inside of a car parked outside in hot weather.
 - * Under direct sunlight.
 - * Humid or corrosive locations.
 - * Keep away from hot surfaces, flammable substances or explosive gas.
 - 12) The nose cleaner should not be used in any conditions other than those described above.

WARNING

Use this product only for its intended use as described in this manual. Do not use attachments not recommended by Oricom.

RISK OF EXPLOSION IF BATTERY IS REPLACED BY AN INCORRECT TYPE.
REPLACE ONLY WITH ALKALINE BATTERIES AAA LR03 (not supplied).

For any questions regarding Oricom CLEANOZ™, please contact the Oricom Support Team online at support@oricom.com.au or 1300 889 785/ 02 4574 8888

BATTERY SAFETY

WARNING

- Batteries represent a hazard to health and the environment!
- They may contain toxic, ecologically hazardous heavy metals.
- Do not dispose of batteries in a fire as they may explode.
- Dispose of batteries according to local regulations, never in your household rubbish.
- Do not dismantle, cut, open, crush, bend, puncture or shred cells or batteries. If a battery leaks, do not let the battery liquid touch skin or eyes. If this happens, immediately flush the affected areas with water, and seek medical assistance.
- Do not modify, remanufacture, attempt to insert foreign objects into the battery, or immerse or expose it to water or other liquids. Batteries may explode if damaged.
- Use only AAA LR03 Alkaline batteries (not supplied). Improper use, or use of unapproved batteries may present a risk of fire, explosion, or other hazard, and may invalidate any approval or warranty.
- If you believe the batteries are damaged, stop using the product. Contact Oricom for assistance. Never use a damaged battery.

MEDICAL WARNING

CAUTION: THE DISPOSABLE RESERVOIR NOZZLE PIECE CONTAINS A LATEX BAG WHICH MAY CAUSE ALLERGENIC REACTIONS.

- 1) Wash your hands before and after using CLEANOZ™.
- 2) Do not push nozzle deep into baby's nostril. Use CLEANOZ™ in the recommended direction.

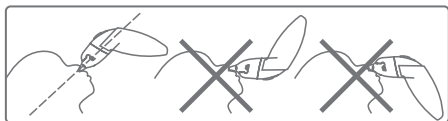

- 3) For the baby's security, aspiration time is limited to a few seconds.
- 4) Do not use CLEANOZ™ in case of nasal irritation or hemorrhage.
- 5) In the case of infection, fever, nasal irritation or hemorrhage, please consult a doctor.
- 6) Do not use CLEANOZ™ without disposable nozzle piece or with a deteriorated bag.
- 7) Use CLEANOZ™ only with recommended disposable nozzle piece (MB002TIPS)
- 8) Change the disposable nozzle piece after each use.

INSTRUCTIONS FOR USE

Oricom CLEANOZ™ is a battery operated nasal aspirator for babies.
Oricom CLEANOZ™ Nasal Aspirator Kit includes 1 Nasal Aspirator and
1 disposable tip.

- 1) For the first use: Open the battery compartment by removing the cover from the nasal aspirator (use a screwdriver to unscrew). Insert three AAA LR03 Alkaline batteries (not supplied) then close the compartment.

Use only Alkaline batteries and observe correct polarity.

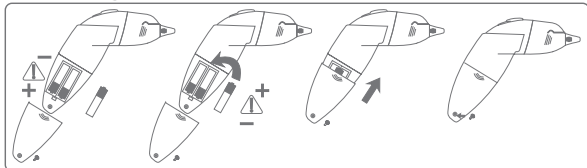

- 2) Insert a new disposable reservoir nozzle piece by aligning the upper silicone guide nodule with the closed edge of the transparent tank. Please be careful not to damage the bag upon insertion.

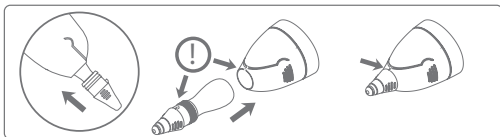

- 3) Position the disposable nozzle just at the opening of the nostril.
To improve the efficiency of CLEANOZ™, it is recommended to irrigate nasal passages with Saline solution, before aspirating secretions.

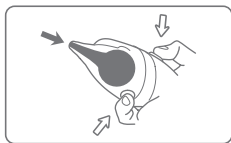
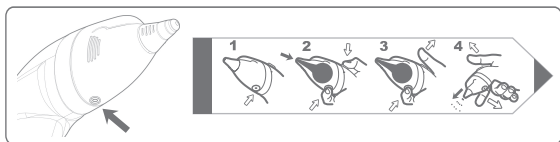

- 4) Switching on: Press the switch while covering the venting hole with your finger tip. The secretions are collected in the reservoir bag.

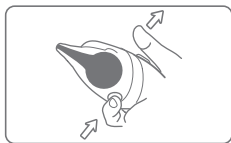

- 5) Switching off: The suction stops automatically a few seconds later when the bag is full.
DO NOT RELEASE THE VENTING HOLE



- 6) Empty the reservoir over a tissue by uncovering the venting hole before cleaning and reusing the nasal aspirator.

- 7) Empty, remove and discard the disposable reservoir nozzle piece after use.

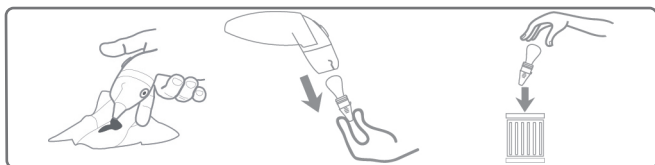

Additional disposable reservoir nozzle pieces can be purchased separately (box 10) at your local Baby Care Retailer or www.oricom.com.au Part No. MB002TIPS.

CLEANING AFTER USE

- 1) The nozzle piece is **disposable**; discard it after use.

Never use the same reservoir nozzle piece on different babies!
Never reuse the same nozzle tip overnight!

- 2) Cleaning the main unit: Make sure that the battery compartment is closed before cleaning the main unit. Do not clean the nose cleaner with solvents or abrasive products.
- 3) Do not immerse the nasal aspirator in liquid. Do not aspirate with any product, but water, with CLEANOZ™.

STORAGE

- 1) Store CLEANOZ™ in a dry place at room temperature. CLEANOZ™ and the disposable reservoir nozzle pieces must be stored in appropriate conditions: Temp between 5 C and 45 C (41 C and 113 F).
- 2) If not used for several months, it is recommended to remove the batteries.

EXPRESS WARRANTY (AUSTRALIA)

This Express Warranty is provided by Oricom International Pty Ltd ABN 46 086116 369, Unit 1, 4 Sovereign Place, South Windsor NSW 2756, herein after referred to as "Oricom".

Oricom products come with guarantees that cannot be excluded under the Australian Consumer Law. You are entitled to a replacement or refund for a major failure and compensation for any other reasonably foreseeable loss or damage. You are also entitled to have the goods repaired or replaced if the goods fail to be of acceptable quality and the failure does not amount to a major failure.

Oricom warrants that the product is free from defects in materials or workmanship during the Express Warranty Period. This Express Warranty does not extend to any product from which the serial number has been removed or was purchased outside of Australia.

Nothing in this Express Warranty excludes, restricts or modifies any condition, warranty, guarantee, implied term, right or remedy pursuant to the Australian Consumer Law and which may not be so excluded, restricted or modified. For such conditions, terms, guarantees and warranties that cannot be excluded, restricted or modified, Oricom limits the remedies available to extent permitted in the relevant legislation.

The Express Warranty Period will be 12 months from the date of purchase of the product evidenced by your dated sales receipt. You are required to provide proof of purchase as a condition of receiving Express Warranty services. You are entitled to a replacement product or repair of the product at our discretion according to the terms and conditions of this document if your product is found to be faulty within the Express Warranty Period. This Express Warranty extends to the original purchaser only and is not transferable.

Products distributed by Oricom are manufactured using new materials or new and used materials equivalent to new in performance and reliability. Spare parts may be new or equivalent to new. Spare parts are warranted to be free from defects in material or workmanship for thirty (30) days or for the remainder of the Express Warranty Period of the Oricom branded product in which they are installed, whichever is longer. During the Express Warranty Period, Oricom will where possible repair and if not replace the faulty product or part thereof. All component parts removed under this Express Warranty become the property of Oricom. In the unlikely event that your Oricom product has a recurring failure, Oricom may always, subject to the Competition and Consumer Act 2010, at its discretion, elect to provide you with a replacement product of its choosing that is at least equivalent to your product in performance.

No change to the conditions of this Express Warranty is valid unless it is made in writing and signed by an authorised representative of Oricom.

EXPRESS WARRANTY (AUSTRALIA)

Oricom will not be liable under this Express Warranty, and to the extent permitted by law will not be liable for any defect, loss, damage or injury arising out of or in connection with a:

1. failure by you to adhere to the warnings and follow the instructions set out in this user guide for the proper installation and use of the product;
2. wilful misconduct or deliberate misuse by you of the product;
3. any external cause beyond our control, including but not limited to power failure, lightning or over voltage; or
4. modification to the product or services carried out on the product by anyone other than Oricom or Oricom's authorised service provider.

How to make a claim under your Express Warranty in Australia

Oricom has a simple warranty process for you to follow:

- Please call or email our Customer Support Team, 1300 889 785, 02 45748888 or support@oricom.com.au.
- A Customer Support Team member will verify after troubleshooting with you if your product qualifies under warranty. If so, they will give you a Product Return Authorisation number.
- We will then email or fax a Return Authorisation form and a Repair Notice (if necessary), together with instructions on how to return the goods for warranty service.

Please note that if a Customer Support Team member advises that your product does not qualify for return, this warranty does not apply to your product. Products that are authorised to be returned to Oricom in Australia must include all of the following:

- A completed Return Authorisation form
- A copy of your Proof of Purchase (please keep your original copy)
- The faulty product, including all accessories.

Send the approved returns to:

Oricom International Pty Ltd
Locked Bag 658
South Windsor NSW 2756 Australia

Please note that this Express Warranty excludes expenses incurred by you in returning any faulty product to us. You must arrange and pay any expenses incurred (including postage, delivery, freight, transportation or insurance of the product) to return the faulty product to us, however, we will arrange delivery of the repaired or replaced faulty product to you.

Important Information Repair Notice

Please be aware that goods presented for repair may be replaced by refurbished goods or parts of the same type rather than being repaired.

TROUBLESHOOTING GUIDE

If you are unable to solve your problem by means of the troubleshooting guide below, contact Customer Support at: support@oricom.com.au or call 1300 889 785/ 02 4574 8888 (8AM to 6PM AEST, Monday to Friday).

PROBLEM

SOLUTION

The CLEANOZ™ does not work: If the problem persists:

Check the polarity of the batteries.
Remove and change the batteries.

No Suction; the disposable reservoir doesn't inflate

Did you cover the transparent tank hole with your finger during suction

If a damaged bag lets secretions penetrate inside the vacuum pump of CLEANOZ™:

Remove the damaged disposable nozzle piece and aspirate clear water for 5 seconds with the CLEANOZ™, then aspirate air for 5 seconds to dry the pump. Dry the transparent tank with a soft cloth. Your CLEANOZ™ is now ready to be used with a new disposable nozzle piece.

To avoid this incident, be careful not to damage the reservoir bag when putting on a new nozzle piece.

CONTACT FOR SUPPORT AND WARRANTY

Australia

Unit 1, 4 Sovereign Place

South Windsor, NSW 2756 Australia

Email: support@oricom.com.au

Phone: 1300 889 785 or (02) 4574 8888

(Monday to Friday 8am to 6pm AEST)

Web: www.oricom.com.au

Fax: (02) 4574 8898

New Zealand

Email: support@oricom.co.nz

Phone: 0800 674 266

(Monday to Friday 10am to 8pm

NZST) Web: www.oricom.co.nz



0543 FCC part 15 compliant, IP40



Disposal - Always dispose of your products at the end of their life in accordance with your local waste disposal requirements. Packaging materials all cardboard and paper packaging should be recycled in accordance with your local council waste regulations. Always remove the batteries from the unit before placing in storage as the battery may leak.

Use 3 x 1.5V AAA LR03 Alkaline Batteries

Protected by US and International Patents Pending. Design U.S. Des. Pat. 542 915.

UBIMED® and CLEANOZ™ are United States registered trademarks of UBIMED® Inc. Culver City, CA 90232, US

IMPORTED & DISTRIBUTED IN AUSTRALIA by:

Oricom International Pty Ltd, Unit 1, 4 Sovereign Place, South Windsor NSW 2756

Oricom® is the registered trademark of Oricom International Pty Ltd. All other trademarks are trademarks of their respective owners.